

# Introduction to Cellular Networks: 1G/2G/3G

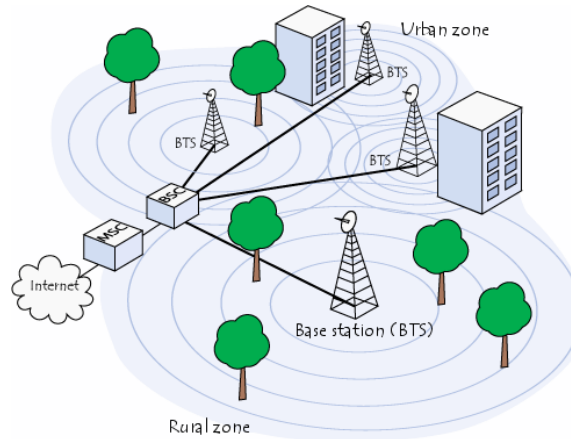

Raj Jain

Washington University in Saint Louis

Saint Louis, MO 63130

Jain@cse.wustl.edu

Audio/Video recordings of this class lecture are available at:

<http://www.cse.wustl.edu/~jain/cse574-18/>



1. Cellular Telephony
2. Cellular Frequency Reuse
3. 2G: GSM
4. 2.5G: GPRS, EDGE
5. 3G: W-CDMA
6. 3.5G: High-Speed Packet Access (HSPA)

Note: 3.9G/4G technologies LTE and LTE Advanced discussed in future lectures of this class.

# Cellular Network Beginnings

- ❑ AT&T Bell Labs designed a cellular structure to reuse frequency. No two adjacent cells use the same frequency.
- ❑ 1977: FCC authorized two commercial deployments
  - Chicago: Illinois Bell
  - Washington, DC: American Radio telephone Service
  - Both services started 1983

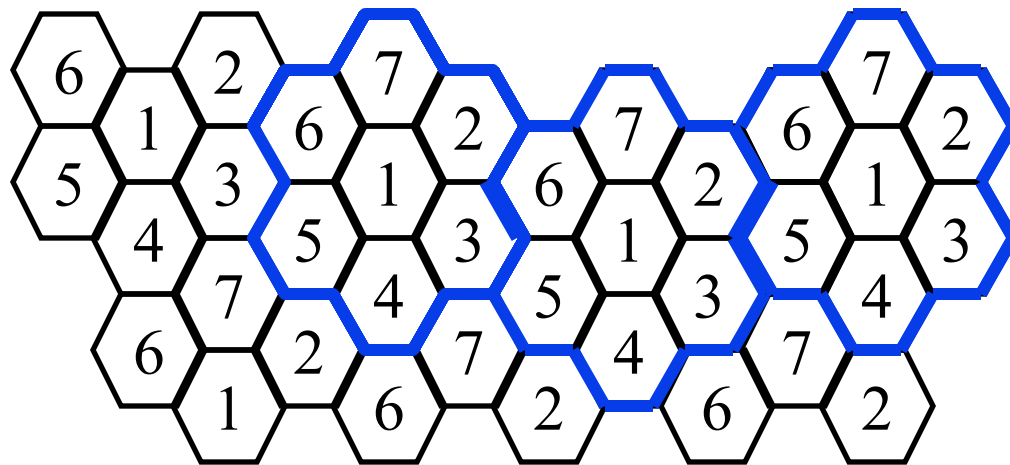

# Initial Cellular System in US

- ❑ US was divided into
  - 306 metropolitan service areas (MSAs)  
75% of US population, 20% of area  
Densely populated  $\Rightarrow$  Small cell size
  - 428 rural service areas (RSAs)  
Less populated  $\Rightarrow$  Larger cell size
- ❑ Each area was originally allowed two competing carriers: A, B
  - Bell (B)
  - Alternative (A)
- ❑ 832 channel-pairs in each area. 416 pairs per carrier.  
45 MHz between transmit and receive frequencies  
30 kHz per channel  
1:7 Frequency reuse with hexagonal cells
- ❑ Too many applicants  $\Rightarrow$  FCC started a lottery system
- ❑ At least one system in every market by 1990

# Cell Sites

- ❑ On towers, roof tops, water tanks, utility poles, ...
  - Good source of income for utility companies, cities, schools, churches, hotels, ...
  - With a base station for electronics
  - NIMBY (Not in my back yard)
    - ⇒ Mostly hidden, shared towers



# Cells on Wheels (CoWs)

- Used for temporary surge in traffic, e.g., games, fares, ...

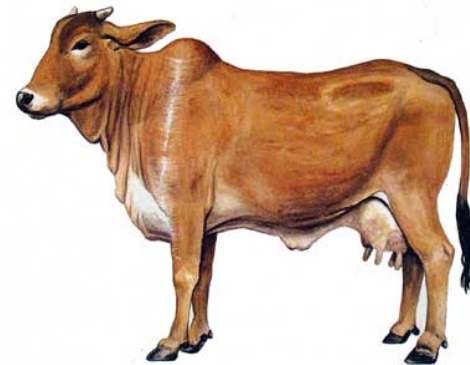

# Macro, Micro, Pico, Femto Cells

- ❑ Macro: Sections of a city, more than 1 km radius
- ❑ Micro: Neighborhoods, less than 1 km
- ❑ Pico: Busy public areas: Malls, airports, ..., 200 m
- ❑ Femto: Inside a home, 10 m

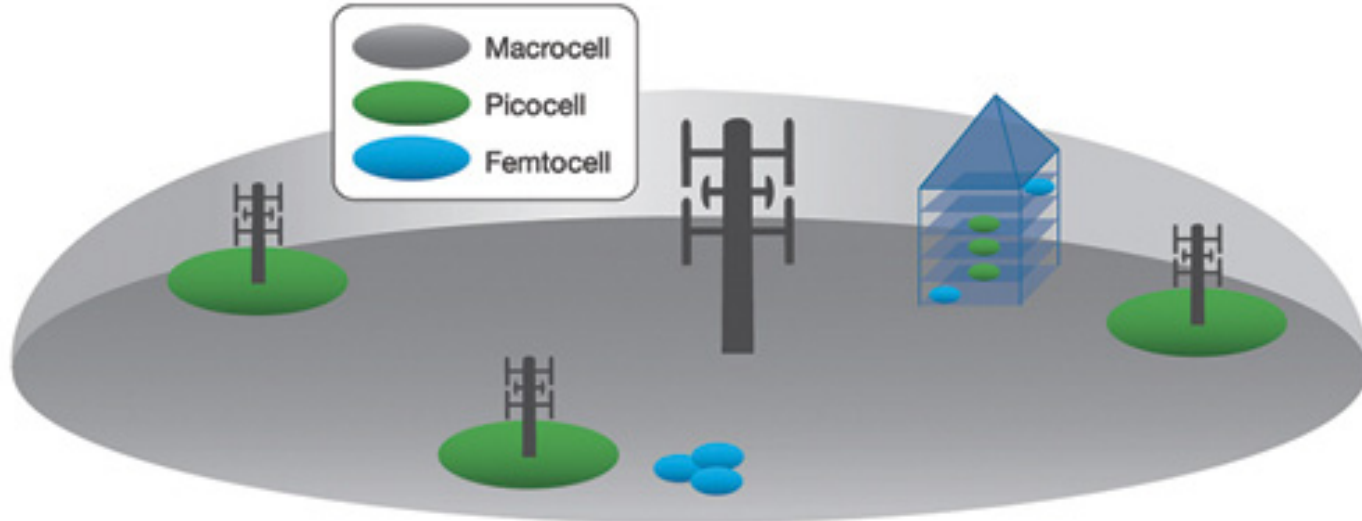

Ref: <http://www.microwavejournal.com/articles/print/22784-high-efficiency-amplifier-for-picocells>

Washington University in St. Louis

<http://www.cse.wustl.edu/~jain/cse574-18/>

©2018 Raj Jain

# Cellular Frequency Reuse

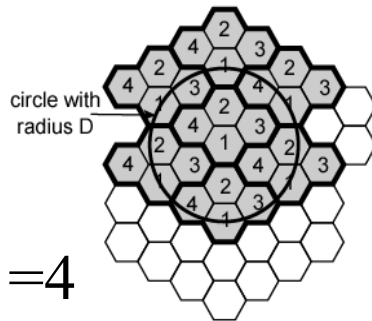

Cluster Size = 4

(a) Frequency reuse pattern for  $N = 4$

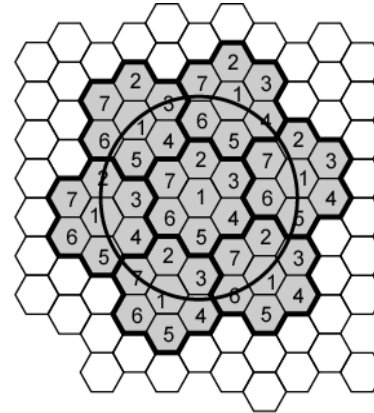

Cluster Size = 7

(b) Frequency reuse pattern for  $N = 7$

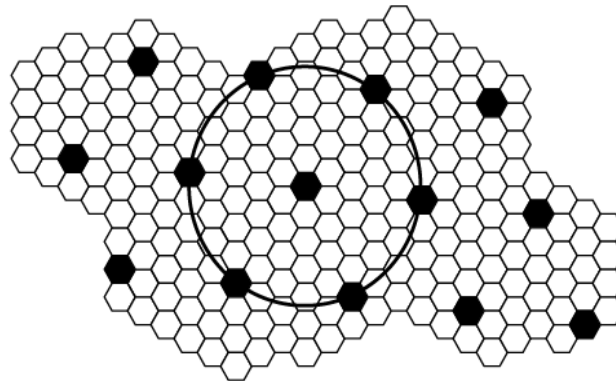

Cluster Size = 19

(c) Black cells indicate a frequency reuse for  $N = 19$



# Characterizing Frequency Reuse

- ❑  $D$  = minimum distance between centers of cells that use the same band of frequencies (called co-channels)
- ❑  $R$  = radius of a cell
- ❑  $d$  = distance between centers of adjacent cells ( $d = R\sqrt{3}$ )
- ❑  $N$  = number of cells in repetitious pattern (**Cluster**)
  - Reuse factor
  - Each cell in pattern uses unique band of frequencies
- ❑ Hexagonal cell pattern, following values of  $N$  possible
  - $N = I^2 + J^2 + (I \times J)$ ,  $I, J = 0, 1, 2, 3, \dots$
- ❑ Possible values of  $N$  are 1, 3, 4, 7, 9, 12, 13, 16, 19, 21, ...
- ❑ Reuse Ratio = Distance/Radius =  $D/R = \sqrt{3N}$
- ❑  $D/d = \sqrt{N}$

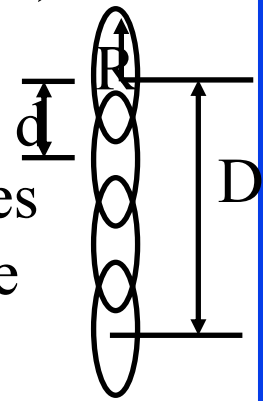

Ref: C. Siva Ram Murthy; B. S. Manoj, "Ad Hoc Wireless Networks Architectures and Protocols," Prentice Hall, 2004, ISBN: 013147023X, 880 pp., Safari Book, Section 3.2.

# Frequency Reuse Example

What would be the minimum distance between the centers of two cells with the same band of frequencies if cell radius is 1 km and the reuse factor is 12?

$$D/R = \sqrt{3N}$$

$$\begin{aligned} D &= (3 \times 12)^{1/2} \times 1 \text{ km} \\ &= 6 \text{ km} \end{aligned}$$

# Homework 16A

- The distance between cell centers with the same frequency band is required to be more than 6 km. What is the cell radius for the cluster size of 12.

# Frequency Reuse Notation

- $N \times S \times K$  frequency reuse pattern
- $N$  = Number of cells per cluster
- $S$  = Number of sectors in a cell
- $K$  = Number of frequency allocations per cell

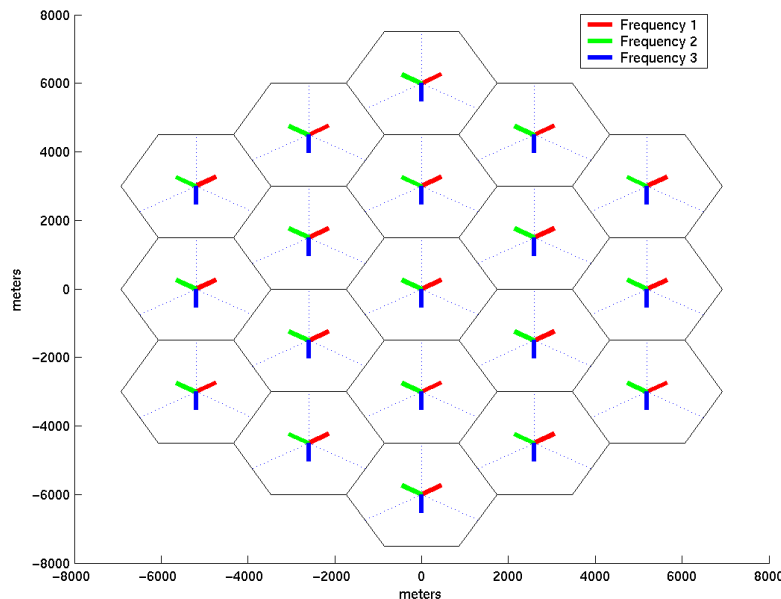

1X3X3

# Frequency Reuse Notation (Cont)

1x3x1

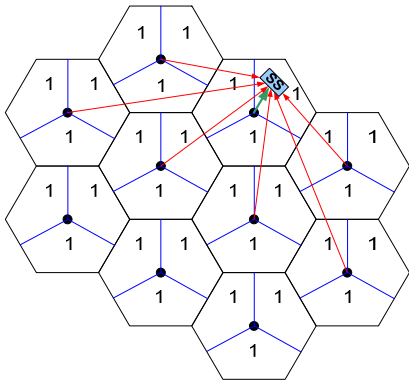

1x3x3

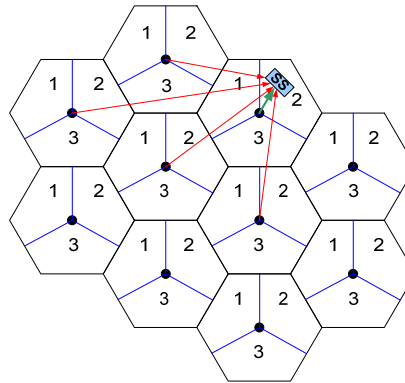

1x1x1

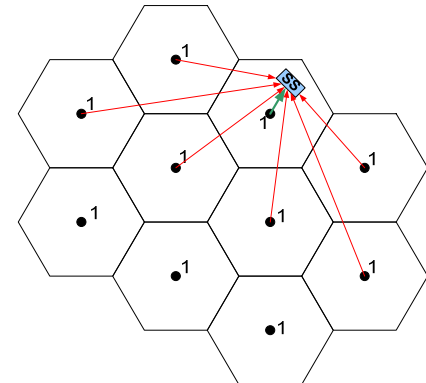

3x1x1

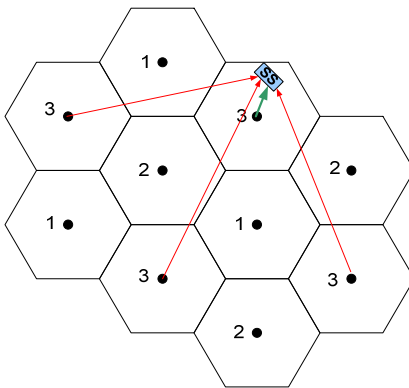

3x3x1

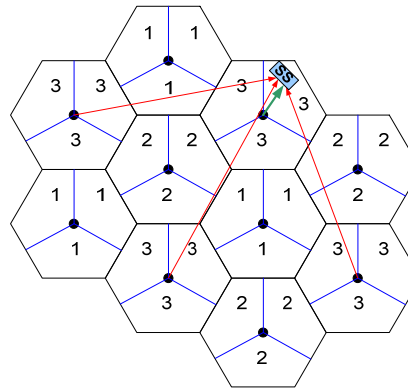

3x3x3

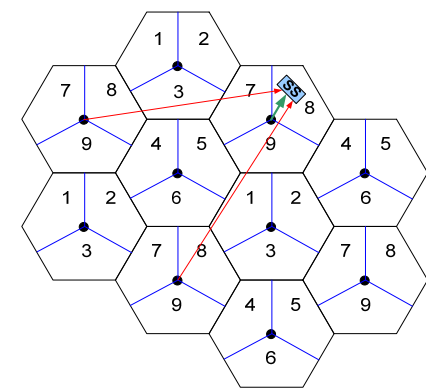

# Fractional Frequency Reuse

- ❑ Users close to the BS use all frequency subchannels
- ❑ Users at the cell boundary use only a fraction of available subchannels

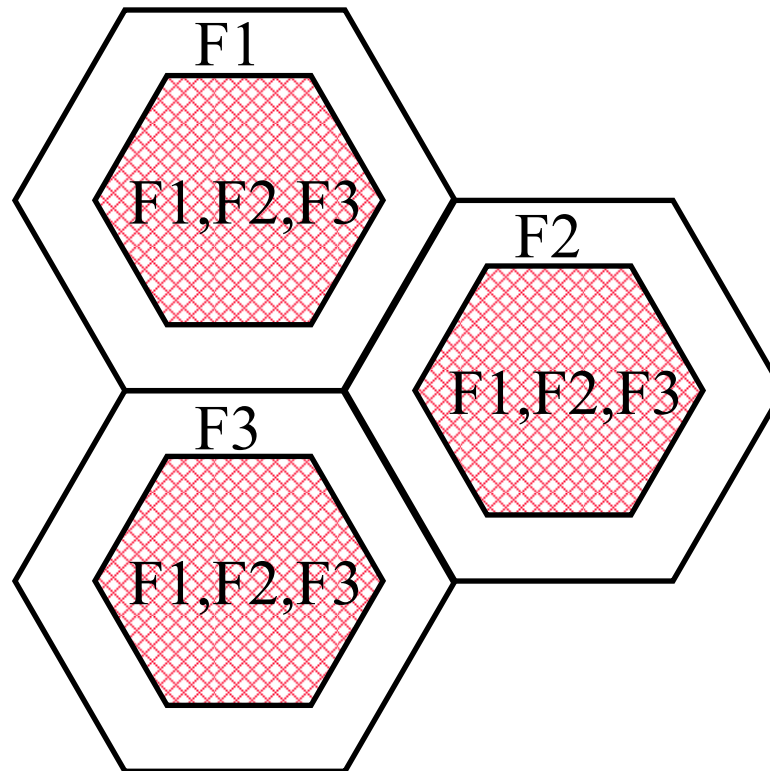

# Homework 16B

- Label the frequency reuse patterns below.

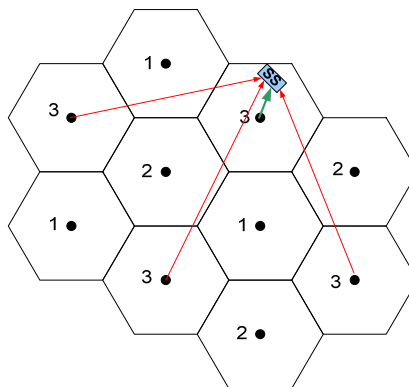
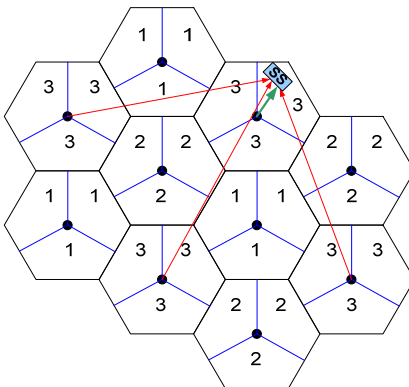
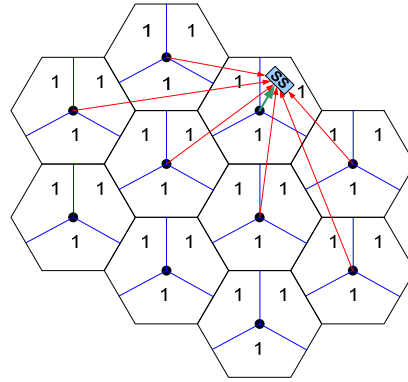
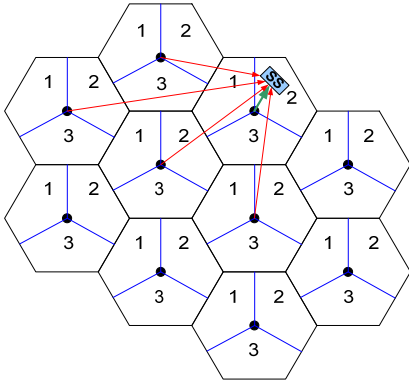

# Cellular Telephony Generations

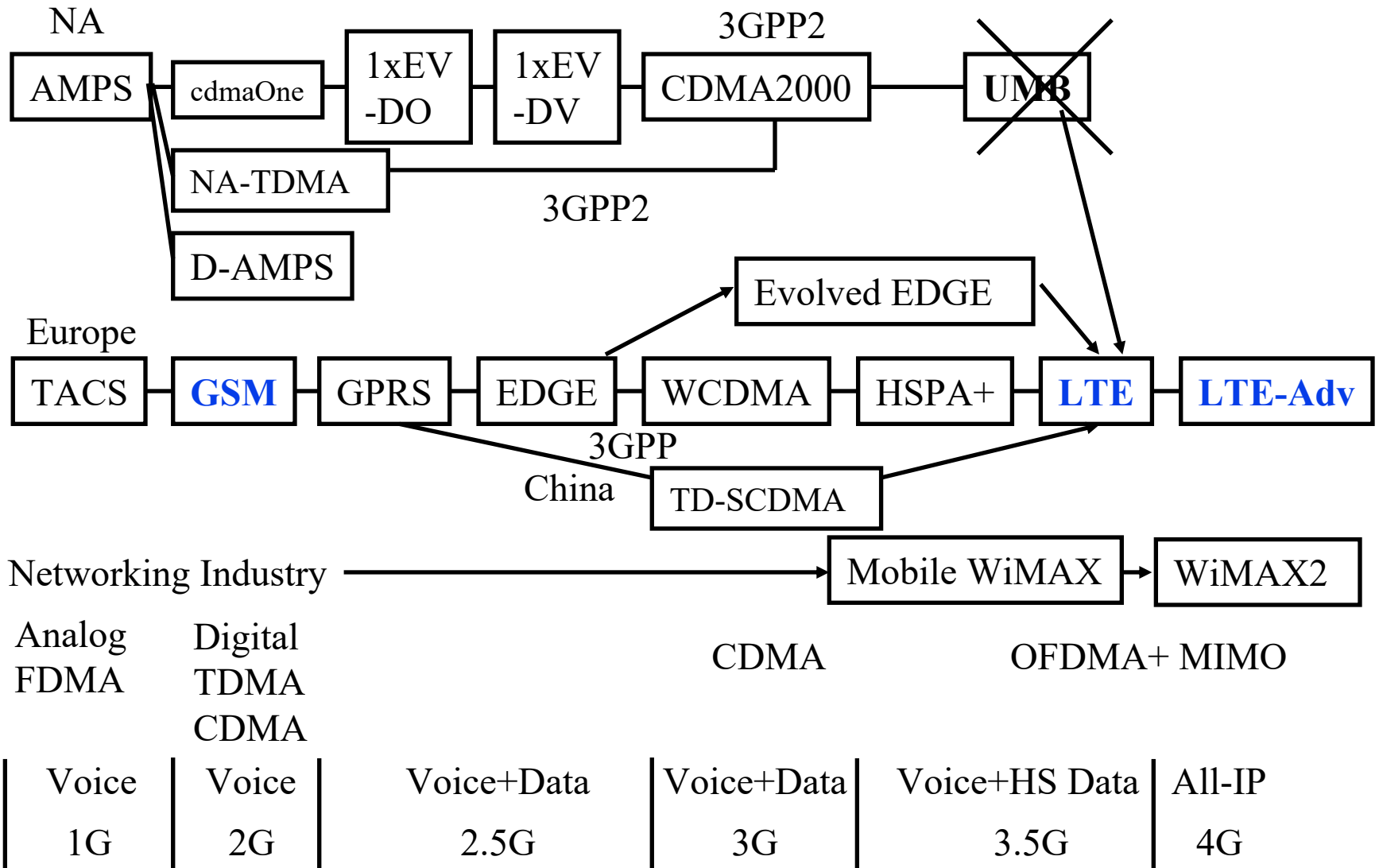



# Cellular Generations (Cont)

## ❑ 1G: Analog Voice. FDMA. 1980s

- AMPS: Advanced Mobile Phone System
- TACS: Total Access Communications System

## ❑ 2G: Digital Voice. TDMA. 1990

- cdmaOne: Qualcomm. International Standard IS-95.
- NA-TDMA
- Digital AMPS (D-AMPS)
- **GSM**: Global System for Mobile Communications

## ❑ 2.5G: Voice + Data. 1995.

- 1xEV-DO: Evolution Data Optimized
- 1xEV-DV: Evolution Data and Voice
- General Packet Radio Service (GPRS)
- Enhanced Data Rate for GSM Evolution (EDGE)

# Cellular Generations (Cont)

## □ 3G: Voice + High-speed data. All CDMA. 2000.

- CDMA2000: Qualcomm. International Standard IS-2000.
- W-CDMA: Wideband CDMA
- TD-SCDMA: Time Division Synchronous Code Division Multiple Access (Chinese 3G)
- 384 kbps to 2 Mbps

## □ 3.5G: Voice + Higher-speed data

- EDGE Evolution
- High-Speed Packet Access (HSPA)
- Evolved HSPA (HSPA+)
- Ultra Mobile Broadband (UMB)

# Cellular Generations (Cont)

- ❑ Two Tracks for 1G/2G/3G:
  - Europe 3GPP (3<sup>rd</sup> Generation Partnership Project)
  - North America 3GPP2
- ❑ **3.9G: High-Speed Data. VOIP. OFDMA.**
  - WiMAX 16e (Worldwide Interoperability for Microwave Access)
  - Long Term Evolution (LTE)
- ❑ **4G: Very High-Speed Data. 2013.**
  - WiMAX 16m or WiMAX2
  - LTE-Advanced
  - 100 Mbps – 1 Gbps
- ❑ **5G: Ultra High-Speed Data. 2020.**
  - IP based

## 3.9G vs. 4G

- ❑ 3G = International Mobile Communications 2000 (IMT-2000) = W-CDMA, CDMA2000
- ❑ 4G = IMT-Advanced  
= LTE-Advanced, IEEE 802.16m
- ❑ WiMAX forum officially declared WiMAX to be 3G technology so that they can use spectrum allocated to 3G.
- ❑ WiMAX, LTE are at most 3.9G or “near-4G”  
Some telecom companies are selling them as 4G

# GSM

- ❑ Global System for Mobile Communications
- ❑ Implemented in 90% of cell phones world-wide.
- ❑ 1990 Technology using Time-Division Multiple Access (**TDMA**) in stead of Frequency Division Multiple Access (FDMA) used in 1G
- ❑ 850/900/1800/1900 MHz (quad-band)
- ❑ **Subscriber Identity Module (SIM)** card contained user data. User could use any phone with his/her SIM card

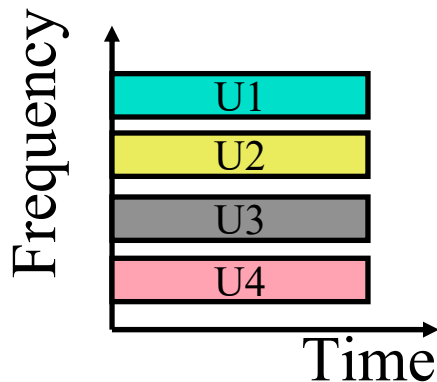

(a) FDMA

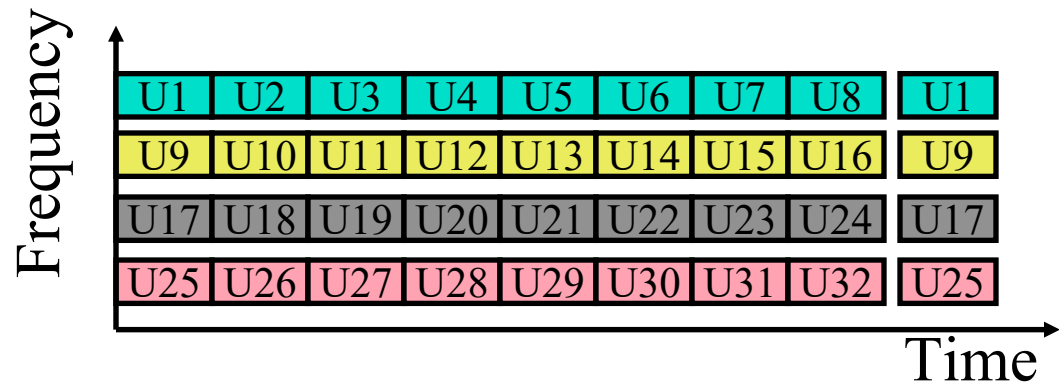

(B) TDMA

# GSM Cellular Architecture

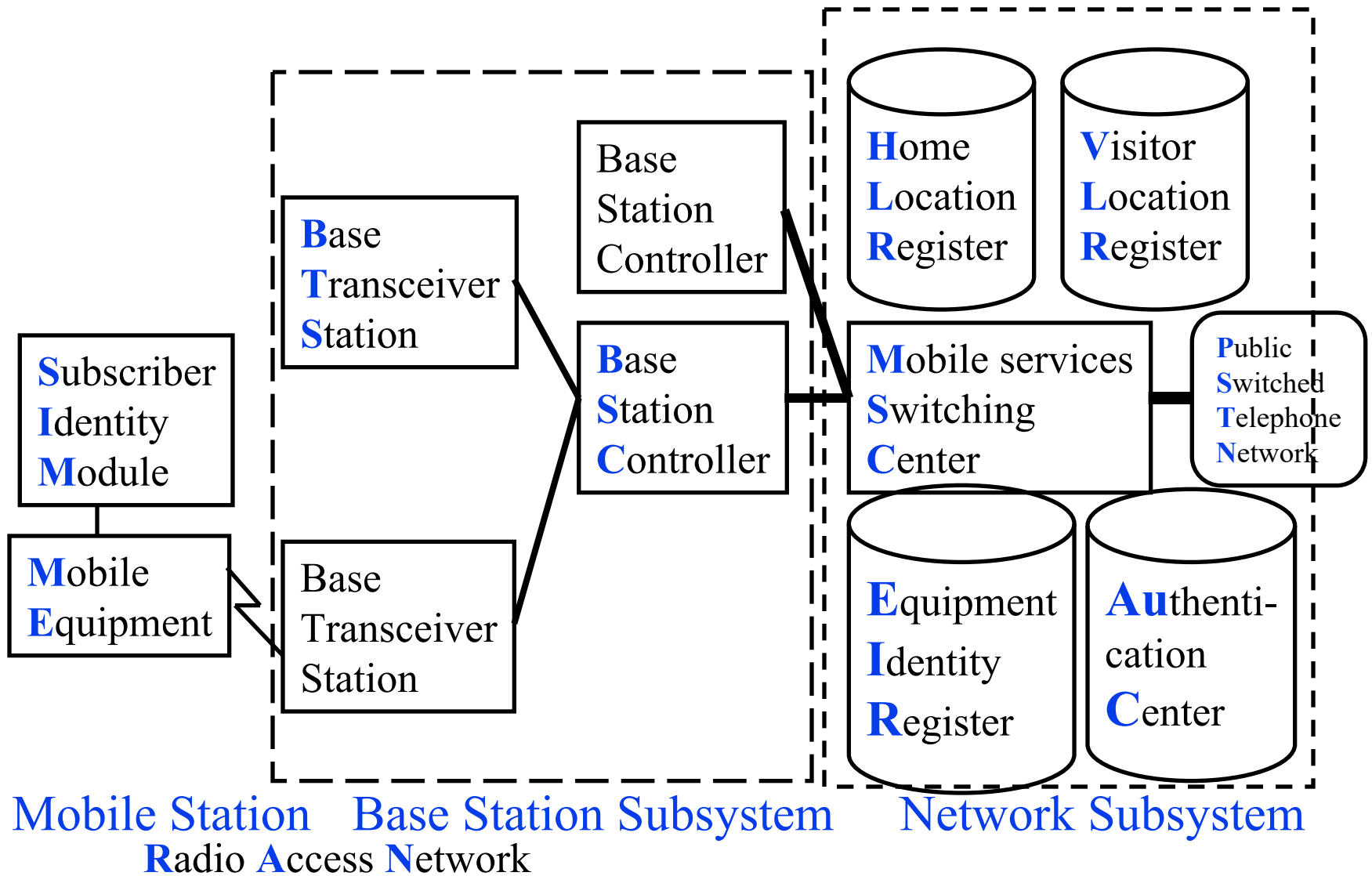

# Cellular Architecture (Cont)

- ❑ One Base transceiver station (BTS) per cell.
- ❑ One Base Station Controller (BSC) can control multiple BTSes.
  - Allocates radio channels among BTSs.
  - Manages call handoffs between BTSs.
  - Controls handset power levels
- ❑ Mobile Switching Center (MSC) connects to PSTN and switches calls between BSCs. Provides mobile registration, location, authentication. Contains Equipment Identity Register.

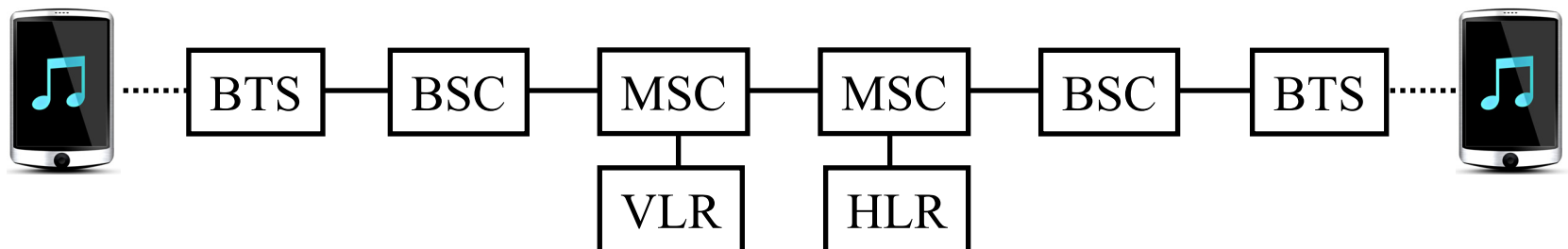

# Cellular Architecture (Cont)

- ❑ **Home Location Register (HLR)** and Visitor Location Register (VLR) provide call routing and roaming
- ❑ VLR+HLR+MSC functions are generally in one equipment
- ❑ Equipment Identity Register (EIR) contains a list of all valid mobiles.
- ❑ Authentication Center (AuC) stores the secret keys of all SIM cards.
- ❑ Each handset has a International Mobile Equipment Identity (IMEI) number.



# GSM Radio Link

Slow Associated  
Control

Traffic Channels (SACCH) Traffic Channels Unused

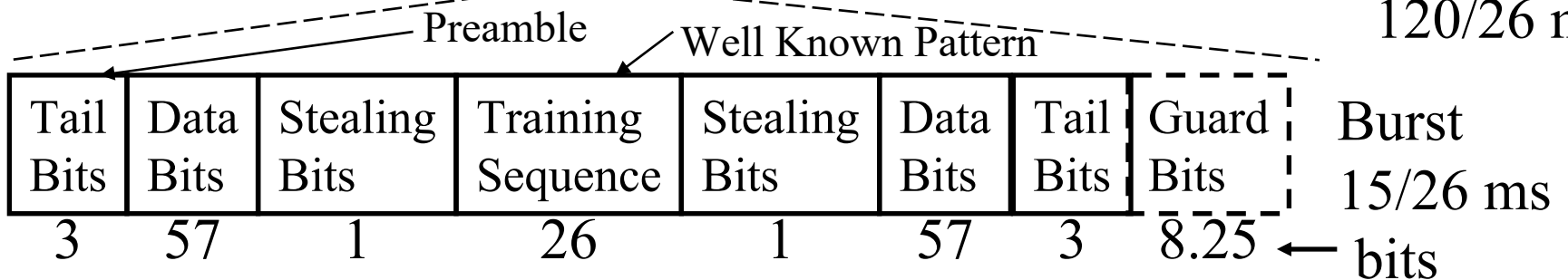
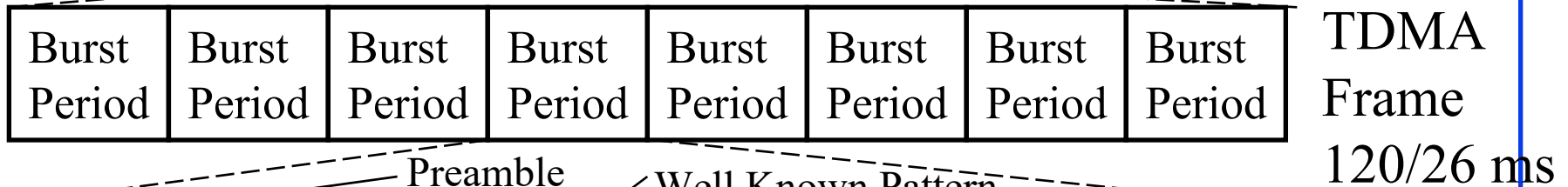
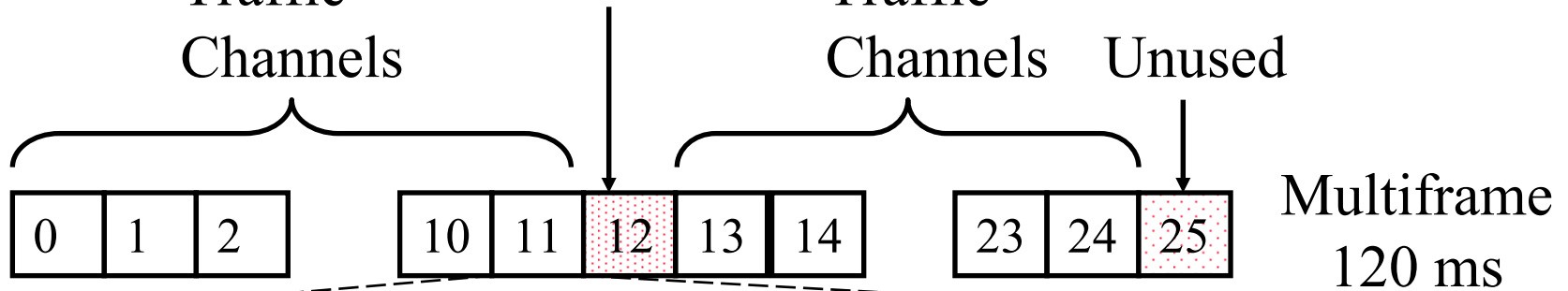

Ref: Martin Sauter, "From GSM to LTE-Advanced: An Introduction to Mobile Networks and Mobile Broadband, Revised Second Edition," John Wiley & Sons, August 2014, 456 pp., ISBN:978-1-118-86195-0 (Safari Book).

# GSM Radio Link (Cont)

- ❑ 890-915 MHz uplink, 935-960 MHz downlink
- ❑ 25 MHz  $\Rightarrow$   $125 \times 200\text{kHz}$  frequency channels
- ❑ Each frequency channel is TDMA with burst (slot) period of  $15/26$  ms.
- ❑ Eight burst periods = TDMA frame of  $120/26$  ms.
- ❑ One user traffic channel = one burst period per TDMA frame.
- ❑ 26 TDMA frames  $\Rightarrow$  one Multiframe
  - 24 are used for traffic, 1 for control, and 1 is unused.
  - Slow Associated Control Channel (SACCH)
  - If SACCH does not have sufficient capacity, Fast Associated Control Channel (FACCH) is used by stealing  $1/2$  of some bursts.
- ❑ **Stealing bits** identify whether the  $1/2$ -slot carries data or control
- ❑ 200 kHz = 270.8 kbps over 26 slots
  - $\Rightarrow$  9.6 kbps/user after encryption and FEC overhead

# GSM Specs

- ❑ Full rate vocoders  $\Rightarrow$  Voice is sampled at 64 kbps compressed to 16 kbps.
- ❑ Subscriber Identify Module (SIM) contains a micro-controller and storage. Contains authentication, encryption, and accounting info.  
Owners need 4-digit PIN.
- ❑ SIM cards can contain additional info such as emergency medical info.
- ❑ Mobile Assisted Handoff: Mobile sends identities of six candidate base stations for handoff. MSC selects.
- ❑ Short Message Service (SMS)
  - Up to 160 characters
  - Sent over control channel
  - Unicast or broadcast

# Cellular System Capacity Example

- A particular cellular system has the following characteristics: cluster size = 7, uniform cell size, user density = 100 users/sq km, allocated frequency spectrum = 900-949 MHz, bit rate required per user = 10 kbps uplink and 10 kbps downlink, and modulation code rate = 1 bps/Hz.
  - A. Using FDMA/FDD:
    1. How much bandwidth is available per cell using FDD?
    2. How many users per cell can be supported using FDMA?
    3. What is the cell area?
    4. What is the cell radius assuming circular cells?
  - B. If the available spectrum is divided into 35 channels and TDMA is employed within each channel:
    1. What is the bandwidth and data rate per channel?
    2. How many time slots are needed in a TDMA frame to support the required number of users?
    3. If the TDMA frame is 10ms, how long is each user slot in the frame?
    4. How many bits are transmitted in each time slot?

# Cellular System Capacity (Cont)

- ❑ A particular cellular system has the following characteristics: cluster size = 7, uniform cell size, user density = 100 users/sq km, allocated frequency spectrum = 900-949 MHz, bit rate required per user = 10 kbps uplink and 10 kbps downlink, and modulation code rate = 1 bps/Hz.
- ❑ A. Using FDMA/FDD:
  1. How much bandwidth is available per cell using FDD?  
 $49 \text{ MHz}/7 = 7 \text{ MHz/cell}$   
FDD  $\Rightarrow$  3.5 MHz/uplink or downlink
  2. How many users per cell can be supported using FDMA?  
 $10 \text{ kbps/user} = 10 \text{ kHz} \Rightarrow 350 \text{ users per cell}$
  3. What is the cell area?  
 $100 \text{ users/sq km} \Rightarrow 3.5 \text{ Sq km/cell}$
  4. What is the cell radius assuming circular cells?  
 $\pi r^2 = 3.5 \Rightarrow r = 1.056 \text{ km}$

# Cellular System Capacity (Cont)

B. If the available spectrum is divided into 35 channels and TDMA is employed within each channel:

1. What is the bandwidth and data rate per channel?

$$3.5 \text{ MHz}/35 = 100 \text{ kHz/Channel} = 100 \text{ kbps}$$

2. How many time slots are needed in a TDMA frame to support the required number of users?

$$10 \text{ kbps/user} \Rightarrow 10 \text{ users/channel}$$

3. If the TDMA frame is 10ms, how long is each user slot in the frame?

$$10 \text{ ms}/10 = 1 \text{ ms}$$

4. How many bits are transmitted in each time slot?

$$1 \text{ ms} \times 100 \text{ kbps} = 100 \text{ b/slot}$$

# Homework 16C

- ❑ A particular cellular system has the following characteristics: cluster size = 9, uniform cell size, user density = 100 users/sq km, allocated frequency spectrum = 900-945 MHz, bit rate required per user = 10 kbps uplink and 10 kbps downlink, and modulation code rate = 2 bps/Hz.
- ❑ A. Using FDMA/FDD:
  - 1. How much bandwidth is available per cell using FDD?
  - 2. How many users per cell can be supported using FDMA?
  - 3. What is the cell area
  - 4. What is the cell radius assuming circular cells?
- B. If the available spectrum is divided into 100 channels and TDMA is employed within each channel:
  - 1. What is the bandwidth and data rate per channel?
  - 2. How many time slots are needed in a TDMA frame to support the required number of users?
  - 3. If the TDMA frame is 10ms, how long is each user slot in the frame?
  - 4. How many bits are transmitted in each time slot?

# GPRS

- ❑ General Packet Radio Service (GPRS). 2.5G Technology
- ❑ Standard GSM has 8 slots per 200 kHz channel
  - One slot/user  $\Rightarrow$  9.6 kbps data/user
- ❑ GPRS allows any number of slots to a user
  - 4 different codings used depending upon channel condition
  - 9.6 kbps to 21.4 kbps per slot
  - 76-171 kbps using all 8 slots.
- ❑ GPRS user can hop frequency channels

$G_i$  = GSM User

$G_{pi}$  = GPRS User

	$t_0$	$t_1$	$t_2$	$t_3$	$t_4$	$t_5$	$t_6$	$t_7$	$t_0$	$t_1$	$t_2$
Uplink 1	G1		G2		GP2			GP1	G1		G2
Uplink 2				GP1			GP2				
Downlink 1	G1	GP1	G2		GP2			GP1	G1		G2
Downlink 2	GP1				GP1					GP2	



# GPRS (Cont)

- ❑ Supports intermittent and bursty data transfers  
Point-to-multipoint also supported
- ❑ Need to add two new elements to GSM networks:
  - **Service** GPRS support node (SGSN)
    - Security, Mobility, Access control for data packet
  - **Gateway** GPRS support node (GGSN)
    - Connects to external packet switched networks
- ❑ Standardized by ETSI

# GSM/GPRS Network Architecture

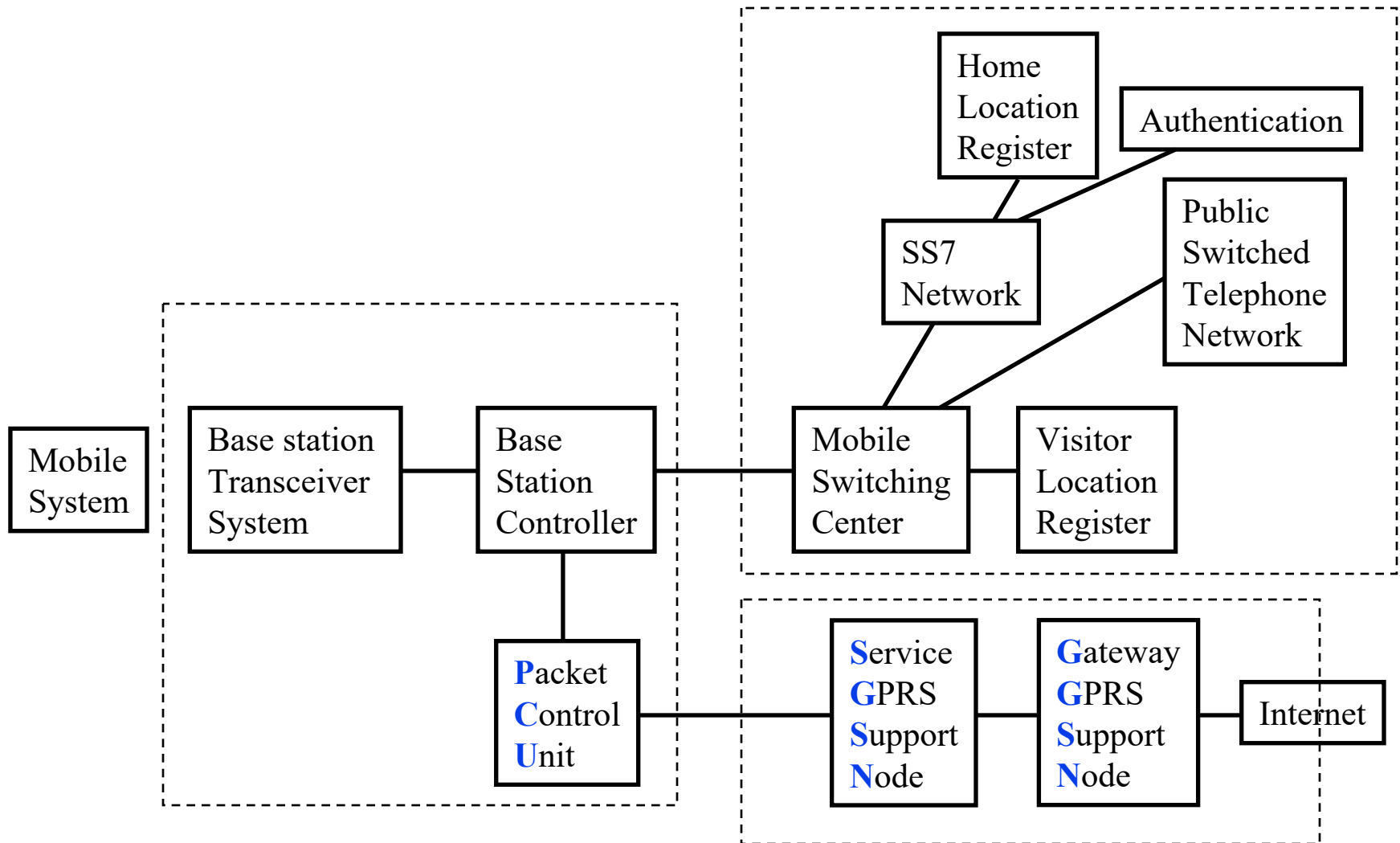

Ref: A. Ghosh, J. Zhang, J. G. Andrews, R. Muhamed, "Fundamentals of LTE," Prentice Hall, 2010, ISBN: 0137033117 464 pp. Safari book.

# EDGE

- ❑ Enhanced Data Rates for GSM Evolution (EDGE)
- ❑ Standard GSM uses Gaussian Minimum Shift Keying (GMSK) modulation.
  - Data stream is shaped with a Gaussian filter before frequency modulation
- ❑ EDGE changes to 8-PSK modulation  $\Rightarrow$  3 bps/Hz
- ❑ GPRS+EDGE  $\Rightarrow$  384 kbps
- ❑ Need better radio signal quality
- ❑ GSM-EDGE Radio Access Network (GERAN)

# W-CDMA

- ❑ Wideband Code Division Multiple Access
- ❑ European 3G
- ❑ Aka Universal Mobile Telecommunications System (UMTS)
- ❑ Uses Direct Sequence Spread Spectrum over two 5 MHz FDD channels
- ❑ Radio access network is called “UMTS Terrestrial Radio Access Network (UTRAN)”
- ❑ Air interface is called “UMTS Terrestrial Radio Access (UTRA)”

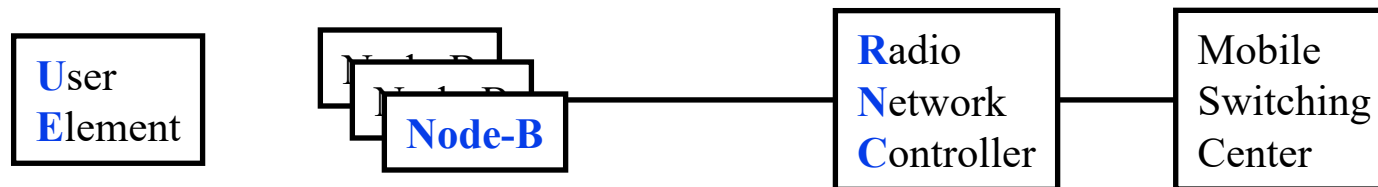

# High-Speed Packet Access (HSPA)

- ❑ Evolution (extension) of W-CDMA
- ❑ High-Speed Downlink **Packet** Access (HSDPA):
  - Adaptive modulation and coding
  - Channel dependent scheduling
  - Higher order modulations, e.g., 16-QAM
- ❑ High-Speed Uplink Packet Access (HSUPA):
  - Parallel transmissions from multiple users
- ❑ HSPA = HSDPA+HSUPA
  - Up to 64-QAM
- ❑ HSPA+: Evolution of HSPA. Up to 168 Mbps down, 22 Mbps up using MIMO and multiple carriers

# Evolved Packet System (EPS)

Radio Access Network

Serving Network Core Network

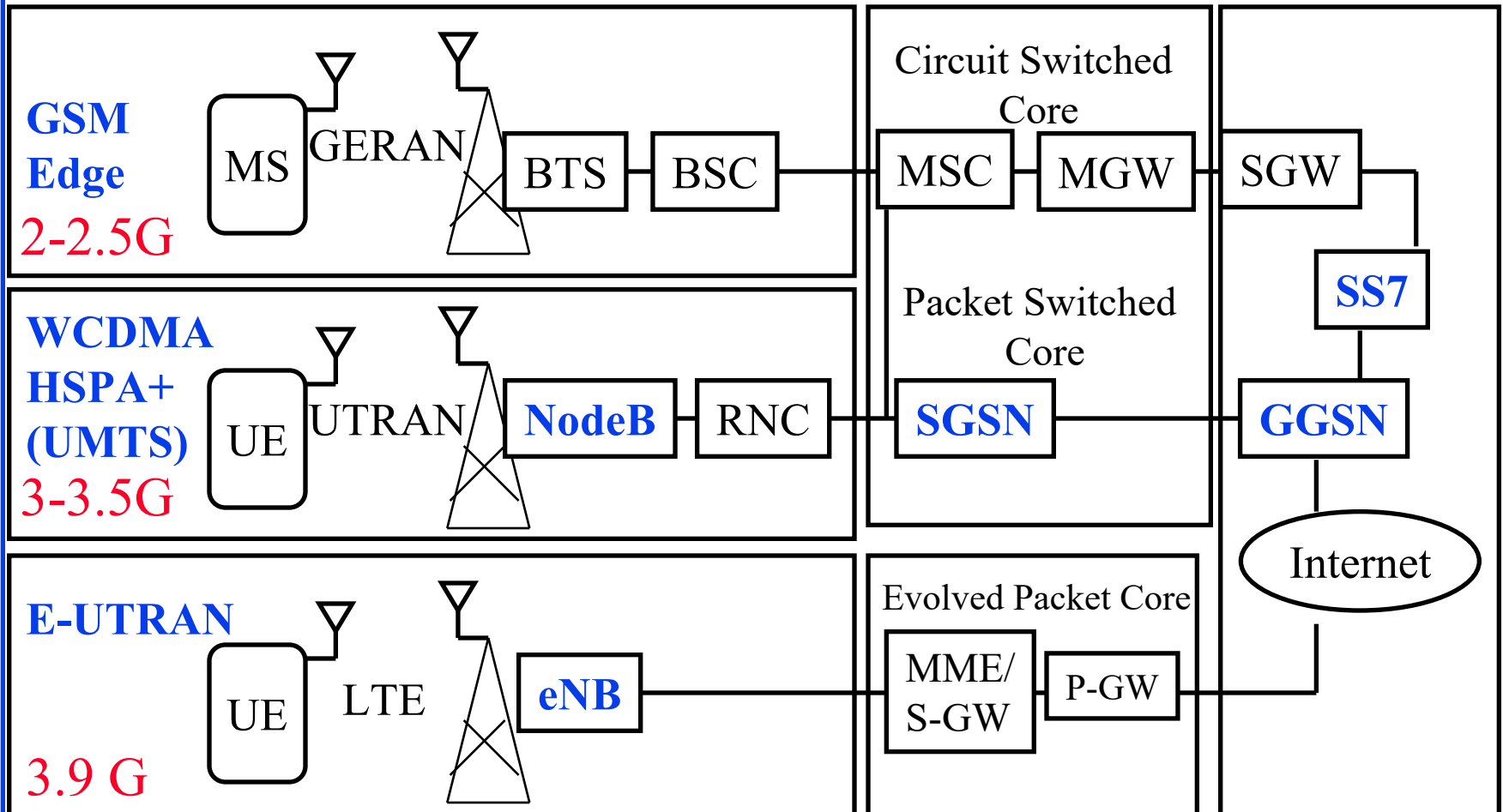

# Evolved Packet System (Cont)

- ❑ CS = Circuit Switched
- ❑ EPC = Evolved Packet Core
- ❑ EPS = Evolved Packet System
- ❑ GERAN = GSM Enhanced Radio Access Network
- ❑ GGSN = Gateway GPRS Support Node
- ❑ LTE = Long Term Evolution
- ❑ MGW = Media Gateway
- ❑ MME = Mobility Management Utility
- ❑ MSC = Mobile Switching Center
- ❑ P-GW = Packet Gateway
- ❑ PS = Packet Switched
- ❑ RNC = Radio Network Control
- ❑ S-GW = Serving Gateway
- ❑ SGSN = Service GPRS Support Node
- ❑ SS7 = Signaling System 7
- ❑ eNB = Evolved NodeB

# Summary

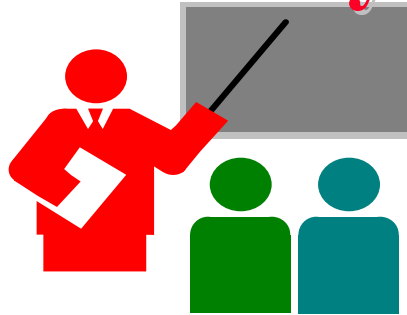

1. In a cellular cluster of size  $N$ , the same distance between cells with same frequencies is  $D = R\sqrt{3N}$ . Here  $R$  is the cell radius.
2. 1G was analog voice with FDMA
3. 2G was digital voice with TDMA. Most widely implemented 2G is GSM. Data rate was improved by GPRS and EDGE.
4. 3G was voice+data with CDMA. Most widely implemented 3G is W-CDMA using two 5 MHz FDD channels.
5. Data rate was improved later using HSPA and HSPA+.



# Reading List

- ❑ Martin Sauter, "From GSM to LTE-Advanced: An Introduction to Mobile Networks and Mobile Broadband, Revised Second Edition," John Wiley & Sons, August 2014, 456 pp., ISBN:978-1-118-86195-0 (Safari Book).
- ❑ C. Siva Ram Murthy; B. S. Manoj, "Ad Hoc Wireless Networks Architectures and Protocols," Prentice Hall, 2004, ISBN: 013147023X, 880 pp., Safari Book.

# Wikipedia Links

- ❑ [http://en.wikipedia.org/wiki/Advanced\\_Mobile\\_Phone\\_System](http://en.wikipedia.org/wiki/Advanced_Mobile_Phone_System)
- ❑ <http://en.wikipedia.org/wiki/CDMA>
- ❑ <http://en.wikipedia.org/wiki/IS-2000>
- ❑ <http://en.wikipedia.org/wiki/IS-95>
- ❑ <http://en.wikipedia.org/wiki/W-CDMA>
- ❑ [http://en.wikipedia.org/wiki/Evolution-Data\\_Optimized](http://en.wikipedia.org/wiki/Evolution-Data_Optimized)
- ❑ [http://en.wikipedia.org/wiki/EV-DV#Potential\\_competing\\_standards](http://en.wikipedia.org/wiki/EV-DV#Potential_competing_standards)
- ❑ <http://en.wikipedia.org/wiki/GSM>
- ❑ <http://en.wikipedia.org/wiki/GPRS>
- ❑ <http://en.wikipedia.org/wiki/EDGE>
- ❑ [http://en.wikipedia.org/wiki/Evolved\\_EDGE](http://en.wikipedia.org/wiki/Evolved_EDGE)
- ❑ <http://en.wikipedia.org/wiki/TD-SCDMA>
- ❑ [http://en.wikipedia.org/wiki/High\\_Speed\\_Packet\\_Access](http://en.wikipedia.org/wiki/High_Speed_Packet_Access)
- ❑ [http://en.wikipedia.org/wiki/Ultra\\_Mobile\\_Broadband](http://en.wikipedia.org/wiki/Ultra_Mobile_Broadband)
- ❑ <http://en.wikipedia.org/wiki/IMT-2000>

# References

- ❑ P. Bedell, “Cellular Networks: Design and Operation, A real World Perspective,” Outskirts Press, 2014, ISBN:9781478732082 (Good/easy reading but not a Safari book)
- ❑ 3G Americas, <http://www.3gamericas.org>
- ❑ 3G Americas,” The mobile broadband revolution: 3GPP Release 8 and beyond, HSPA+, SAE/LTE and LTE-Advanced,” White paper, February 2009.

# Acronyms

- ❑ 3GPP            3rd Generation Partnership Project
- ❑ AMPS            Advanced Mobile Phone System
- ❑ AuC             Authentication Center
- ❑ BS              Base Station
- ❑ BSC             Base Station Controller
- ❑ BTS             Base transceiver station
- ❑ CDMA           Code Division Multiple Access
- ❑ CoW            Cell on Wheels
- ❑ CS              Circuit Switched
- ❑ DC              District of Columbia
- ❑ DO              Data-Only
- ❑ DV              Data+Voice
- ❑ EDGE            Enhanced Data rate for GSM evolution
- ❑ EIR             Equipment Identity Register
- ❑ eNB            eNodeB
- ❑ EPC             Evolved Packet Core

# Acronyms (Cont)

- ❑ EPS Evolved Packet System
- ❑ ETSI European Telecommunications Standards Institute
- ❑ EVDO Evolution to Data only
- ❑ EVDV Evolution to Data and voice
- ❑ FACCH Fast Associated Control Channel
- ❑ FDD Frequency Division Duplexing
- ❑ FDMA Frequency Division Multiple Access
- ❑ FEC Forward Error Correction
- ❑ GERAN GSM Enhanced Radio Access Network
- ❑ GGSN Gateway GPRS Support
- ❑ GMSK Gaussian Minimum Shift Keying
- ❑ GP GPRS user slot
- ❑ GPRS General Packet Radio Service
- ❑ GSM Global System for Mobile Communications
- ❑ GW Gateway
- ❑ HLR Home Location Register

# Acronyms (Cont)

- ❑ HS High Speed
- ❑ HSDPA High-speed Downlink Packet Access
- ❑ HSPA High-speed Packet Access
- ❑ HSPA+ Evolved High-speed Packet Access
- ❑ HSUPA High-Speed Uplink Packet Access
- ❑ IEEE Institution of Electrical and Electronic Engineers
- ❑ IMEI International Mobile Equipment Identity
- ❑ IMT-2000 International Mobile Communications 2000
- ❑ IMT-Advanced International Mobile Communications Advanced
- ❑ IP Internet Protocol
- ❑ IS International Standard
- ❑ kHz Kilo Hertz
- ❑ LTE Long-Term Evolution
- ❑ MGW Media Gateway
- ❑ MHz Mega Hertz
- ❑ MIMO Multiple Input Multiple Output
- ❑ MME Mobility Management Utility

# Acronyms (Cont)

- ❑ MS                    Mobile Station
- ❑ MSA                  Metropolitan Service Areas
- ❑ MSC                  Mobile Switching Center
- ❑ NA-TDMA            North America Time Division Multiple Access
- ❑ NA                    North America
- ❑ NIMBY                Not in my backyard
- ❑ NodeB                Base Station
- ❑ OFDMA                Orthogonal Frequency Division Multiple Access
- ❑ PIN                    Personal Identification Number
- ❑ PS                    Packet Switched
- ❑ PSK                    Phase Shift Keying
- ❑ PSTN                  Public Switched Telephone Network
- ❑ QAM                    Quadrature Amplitude Modulation
- ❑ RNC                    Radio Network Control
- ❑ SACCH                Slow Associated Control Channel

# Acronyms (Cont)

- ❑ SCDMA Synchronous CDMA
- ❑ SGSN Service GPRS Support Node
- ❑ SGW Service Gateway
- ❑ SIM Subscriber Identify Module
- ❑ SMS Short Message Service
- ❑ SS7 Signaling System 7
- ❑ TACS Total Access Communications System
- ❑ TD-SCDMA Time Duplexed Synchronous Code Division Multiple Access
- ❑ TDMA Time Division Multiple Access
- ❑ UE User Element
- ❑ UMB Ultra Mobile Broadband
- ❑ UMTS Universal Mobile Telecommunications System
- ❑ UTRA UMTS Terrestrial Radio Access
- ❑ UTRAN UMTS Terrestrial Radio Access Network
- ❑ VLR Visitor Location Register
- ❑ VOIP Voice over IP



# Acronyms (Cont)

- ❑ WCDMA      Wideband Code Division Multiple Access
- ❑ WiMAX      Worldwide Interoperability for Microwave Access

# Scan This to Download These Slides



Raj Jain

<http://rajjain.com>

# Related Modules



CSE567M: Computer Systems Analysis (Spring 2013),  
[https://www.youtube.com/playlist?list=PLjGG94etKypJEKjNAa1n\\_1X0bWWNyZcof](https://www.youtube.com/playlist?list=PLjGG94etKypJEKjNAa1n_1X0bWWNyZcof)

CSE473S: Introduction to Computer Networks (Fall 2011),  
[https://www.youtube.com/playlist?list=PLjGG94etKypJWOSPMh8Azcg5e\\_10TiDw](https://www.youtube.com/playlist?list=PLjGG94etKypJWOSPMh8Azcg5e_10TiDw)



Recent Advances in Networking (Spring 2013),  
<https://www.youtube.com/playlist?list=PLjGG94etKypLHyBN8mOgwJLHD2FFIMGq5>

CSE571S: Network Security (Fall 2011),  
<https://www.youtube.com/playlist?list=PLjGG94etKypKvzfVtutHcPFJXumyyg93u>



Video Podcasts of Prof. Raj Jain's Lectures,  
<https://www.youtube.com/channel/UCN4-5wzNP9-ruOzQMs-8NUw>