

Internet 3.0:

Ten Problems with Current Internet Architecture and a Proposal for the Next Generation

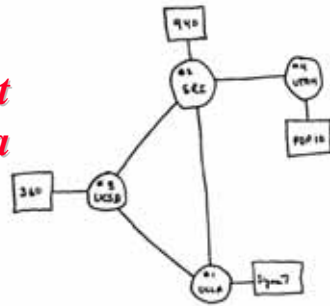

Raj Jain
Washington University in Saint Louis
Saint Louis, MO 63130
Jain@wustl.edu

Keynote Speech at International Conference on Computer and Communications Engineering, (ICCCCE 2008), Kuala Lumpur, May 13-15, 2008

These slides and Audio/Video recordings of this talk are at:
http://www.cse.wustl.edu/~jain/talks/in3_ic.htm



1. What is Internet 3.0?
2. Why should you keep on the top of Internet 3.0?
3. What are we missing in the current Internet?
4. Our Proposed Architecture for Internet 3.0

Internet 3.0

- ❑ US National Science Foundation is planning a \$300M+ research and infrastructure program on next generation Internet
 - Testbed: “Global Environment for Networking Innovations” (GENI)
 - Architecture: “Future Internet Design” (FIND).
- ❑ Q: How would you design Internet today? Clean slate design.
- ❑ Ref: <http://www.nsf.gov/cise/cns/geni/>
- ❑ Most of the networking researchers will be working on GENI/FIND for the coming years
- ❑ Internet 3.0 is the name of the Washington University project on the next generation Internet
- ❑ Named by me along the lines of “Web 2.0”
- ❑ Internet 3.0 is more intuitive than GENI/FIND

Internet Generations

- ❑ **Internet 1.0** (1969 – 1989) – Research project
 - RFC1 is dated April 1969.
 - ARPA project started a few years earlier
 - IP, TCP, UDP
 - Mostly researchers
 - Industry was busy with proprietary protocols: SNA, DECnet, AppleTalk, XNS
- ❑ **Internet 2.0** (1989 – Present) – Commerce ⇒ new requirements
 - Security RFC1108 in 1989
 - NSFnet became commercial
 - Inter-domain routing: OSPF, BGP,
 - IP Multicasting
 - Address Shortage IPv6
 - Congestion Control, Quality of Service,...

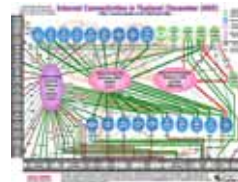
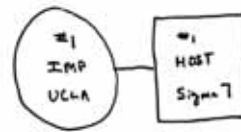

Ten Problems with Current Internet

1. Designed for research
⇒ Trusted systems
Used for Commerce
⇒ Untrusted systems
2. Control, management, and Data path are intermixed ⇒ security issues
3. Difficult to represent organizational, administrative hierarchies and relationships. Perimeter based.

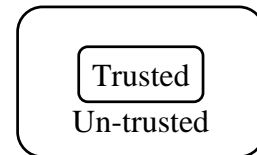

Problems (cont)

4. Identity and location in one (IP Address)
Makes mobility complex.
5. Location independent addressing
⇒ Most services require nearest server.
⇒ Also, Mobility requires location
6. No representation for real end system: the human.



Problems (cont)

7. Assumes live and awake end-systems
Does not allow communication while sleeping.



Many energy conscious systems today sleep.

8. Single-Computer to single-computer communication \Rightarrow Numerous patches needed for communication with globally distributed systems and services.



9. Symmetric Protocols
 \Rightarrow No difference between a PDA and a Google server.



Problems (Cont)

10. Stateless \Rightarrow Can't remember a flow
 \Rightarrow QoS difficult.
QoS is generally for a flow and not for one packet



Our Proposed Solution: Internet 3.0

- ❑ Take the best of what is already known
 - Wireless Networks, Optical networks, ...
 - Transport systems: Airplane, automobile, ...
 - Communication: Wired Phone, Cellular nets,...
- ❑ Develop a consistent general purpose, evolvable architecture that can be customized by implementers, service providers, and users



Washington
University in St. Louis



©2008 Raj Jain

<http://www.cse.wustl.edu/~jain/>

10

Names, IDs, Addresses



Name: John Smith

ID: 012-34-5678

Address:
1234 Main Street
Big City, MO 12345
USA

- ❑ Address changes as you move, ID and Names remain the same.
- ❑ **Examples:**
 - Names: Company names, DNS names (microsoft.com)
 - IDs: Cell phone numbers, 800-numbers, Ethernet addresses, Skype ID, VOIP Phone number
 - Addresses: Wired phone numbers, IP addresses

Washington
University in St. Louis

<http://www.cse.wustl.edu/~jain/>

©2008 Raj Jain

11

Realms

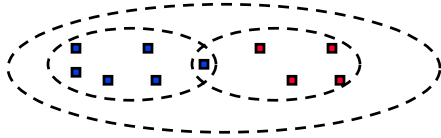

- ❑ Object names and Ids are defined within a realm
- ❑ A realm is a **logical** grouping of objects that have a certain level of **trust**
- ❑ A realm represents an organization
 - Realm managers set policies for communications
 - Realm members can share services.
 - Objects are generally members of multiple realms
- ❑ Realm Boundaries: Organizational, Governmental, ISP, P2P,...

Realm = Organization

Zones

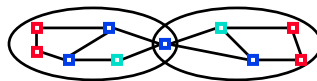

- ❑ Address of an object indicates its **physical attachment point**
- ❑ Networks are organized as a set of **zones**
- ❑ Object address in the current zone is sufficient to reach it inside that zone
- ❑ Zones are **physical** grouping of *attachment points* based on connectivity. Does not imply trust.

Zonal Hierarchy = Network Structure

Physical vs Logical Connectivity

- ❑ Physically and logically connected:
All computers in my lab
= Private Network,
Firewalled Network
- ❑ Physically disconnected but logically connected:
My home and office computers
- ❑ Physically connected but logically disconnected: Passengers on a plane, Neighbors, Conference attendees sharing a wireless network, A visitor



Physical connectivity \neq Trust

Server and Gatekeeper Objects

- ❑ Each realm has a set of server objects, e.g., forwarding, authentication, encryption, storage, transformation, ...
- ❑ Some objects have built-in servers, e.g., an “enterprise router” may have forwarding, encryption, authentication services.
- ❑ Other objects rely on the servers in their realm
- ❑ Authentication servers (AS) add their signatures to packets and verify signatures of received packets..
- ❑ Storage servers store packets while the object may be sleeping and may optionally aggregate/compress/transform data.
Could wake up objects.
- ❑ Objects can appoint proxies for any function(s)
- ❑ Gatekeepers enforce policies: Security, traffic, QoS

Servers allow simple energy efficient end devices

User- Host- and Data Centric Models

- All discussion so far assumed host-centric communication
 - Host mobility and multihoming
 - Policies, services, and trust are related to hosts
- User Centric View:
 - Bob wants to watch a movie
 - Starts it on his media server
 - Continues on his iPod during commute to work
 - Movie exists on many servers
 - Bob may get it from different servers at different times or multiple servers at the same time
- Can we just give addresses to users and treat them as hosts?
 - No! ⇒ Policy Oriented Naming Architecture (PONA)



Policy Oriented Naming Architecture

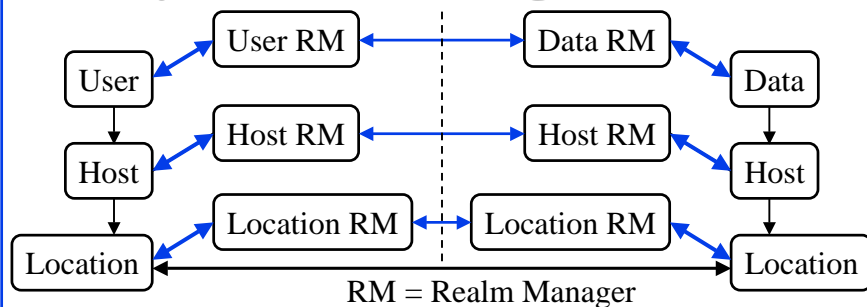

- Both Users and data need hosts for communication
- Data is easily replicable. All copies are equally good.
- Users, Hosts, Infrastructure, Data belong to different realms (organizations).
- Each object has to follow its organizational policies.

PONA (Cont)

- ❑ User and data realms are higher level than host realms
- ❑ Most communication is user-data communication
- ❑ User, Host, and Data can move independently
 - Hosts move from one location to next
 - Users and data can move from one host to the next
- ❑ User ID \Rightarrow Host ID \Rightarrow Host Location = Address
- ❑ User realm managers provide User ID to Host ID translation
- ❑ Realm managers enforce organizational policies
- ❑ Realm managers setup trust relationships between organizations

Virtualizable Network Concept

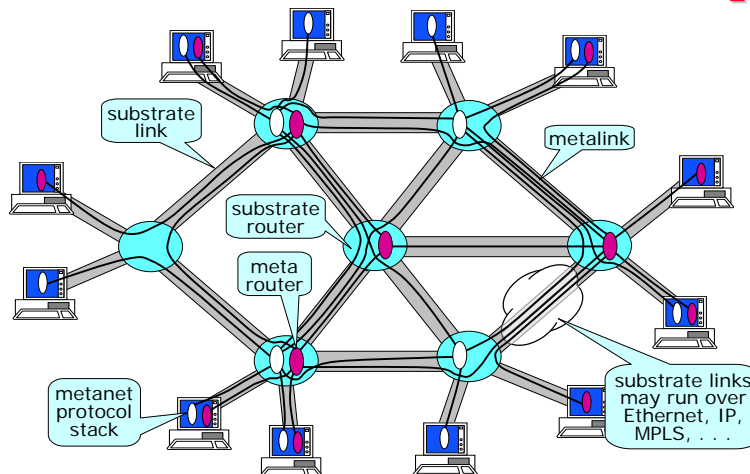

Ref: T. Anderson, L. Peterson, S. Shenker, J. Turner, "Overcoming the Internet Impasse through Virtualization," Computer, April 2005, pp. 34 – 41.

Realm Virtualization

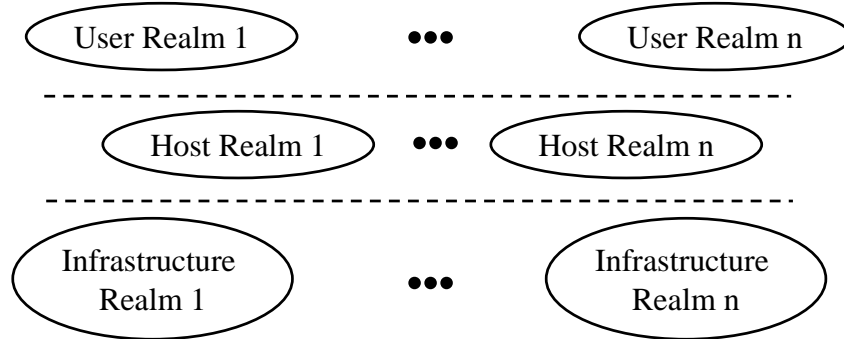

- ❑ Old: Virtual networks on a common infrastructure
- ❑ New: Virtual user realms on virtual host realms on a group of infrastructure realms. 3-level hierarchy not 2-level. Multiple organizations at each level.

Internet 1.0 vs. Internet 3.0

	Feature	Internet 1.0	Internet 3.0
1.	Energy Efficiency	Always-on	Green ⇒ Mostly Off
2.	Mobility	Mostly stationary computers	Mostly mobile <i>objects</i>
3.	Computer-Human Relationship	Multi-user systems ⇒ Machine to machine comm.	Multi-systems user ⇒ Personal comm. systems
4.	End Systems	Single computers	Globally distributed systems
5.	Protocol Symmetry	Communication between equals ⇒ Symmetric	Unequal: PDA vs. big server ⇒ Asymmetric
6.	Design Goal	Research ⇒ Trusted Systems	Commerce ⇒ No Trust Map to organizational structure
7.	Ownership	No concept of ownership	Hierarchy of ownerships, administrations, communities
8.	Sharing	Sharing ⇒ Interference, QoS Issues	Sharing <i>and</i> Isolation ⇒ Critical infrastructure
9.	Switching units	Packets	Packets, Circuits, Wavelengths, Electrical Power Lines, ...
10.	Applications	Email and Telnet	Information Retrieval, Distributed Computing, Distributed Storage, Data diffusion

Summary

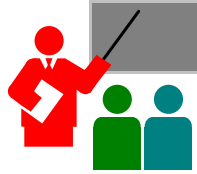

1. Internet 3.0 is the next generation of Internet.
2. It must be secure, allow mobility, and be energy efficient.
3. Must be designed for commerce
⇒ Must represent multi-organizational structure and policies
4. Moving from host centric view to user-data centric view
⇒ Important to represent users and data objects
5. Users, Hosts, and infrastructures belong to different realms (organizations). Users/data/hosts should be able to move freely without interrupting a network connection.

References

1. Jain, R., “Internet 3.0: Ten Problems with Current Internet Architecture and Solutions for the Next Generation,” in Proceedings of Military Communications Conference (MILCOM 2006), Washington, DC, October 23-25, 2006.

References: Coming Soon

2. Jianli Pan, Subharthi Paul, Raj Jain, and Mic Bowman, “MILSA: A Mobility and Multihoming Supporting Identifier-Locator Split Architecture for Naming in the Next Generation Internet,,” submitted to Globecom 2008, Nov 2008.
3. Subharthi Paul, Jianli Pan, Raj Jain and Mic Bowman, “A Survey of Naming Systems: Classification and Analysis of the Current Schemes Using a New Naming Reference Model,” to be submitted for publication, 2008.
4. Subharthi Paul, Raj Jain, Jianli Pan, and Mic Bowman, “A Vision of the Next Generation Internet: A Policy Oriented View,” Submitted to British Computer Society Conference on Visions of Computer Science, Sep 2008.