

# Chapter 4: The Medium Access Sublayer

Raj Jain

Professor of CIS  
The Ohio State University  
Columbus, OH 43210  
Jain@CIS.Ohio-State.Edu

<http://www.cis.ohio-state.edu/~jain/>

The Ohio State University

Raj Jain

1



- 4.2 Multiple Access:  
Aloha, Slotted Aloha, CSMA/CD
- 4.3 IEEE 802 LANs: Ethernet, Token Ring, LLC
- 4.4 Bridges: Transparent, Source Routing, Remote
- 4.5 High Speed LANs: FDDI, Fast Ethernet

The Ohio State University

Raj Jain

2

## Multiple Access Protocols

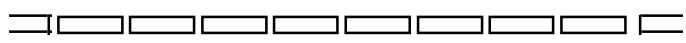
- ❑ Aloha at Univ of Hawaii:  
Transmit whenever you like  
Worst case utilization =  $1/(2e) = 18\%$
- ❑ Slotted Aloha: Fixed size transmission slots  
Worst case utilization =  $1/e = 37\%$   

- ❑ CSMA: Carrier Sense Multiple Access  
Listen before you transmit
- ❑ CSMA/CD: CSMA with Collision Detection  
Listen while transmitting. Stop if you hear someone else

The Ohio State University

Raj Jain

4

## Aloha Performance

- ❑ Let frame time = 1
- ❑  $S$  = New Traffic in Number of frames/unit time
- ❑  $S = 1 \Rightarrow$  Fully loaded system
- ❑  $G$  = New frames + Retransmissions = Total load
- ❑  $S = GP[0]$
- ❑  $P[k \text{ frames/unit time}] = G^k e^{-G} / k!$ ,  $k=1,2,3,\dots$
- ❑  $P[0] = e^{-2G}$
- ❑  $S = Ge^{-2G}$
- ❑ Max  $S = 1/2e$ , at  $G=0.5$
- ❑ For Slotted Aloha:  $S = Ge^{-G} \Rightarrow$  Max  $S = 1/e$  at  $G=1$

The Ohio State University

Raj Jain

5

## Aloha Performance (cont)

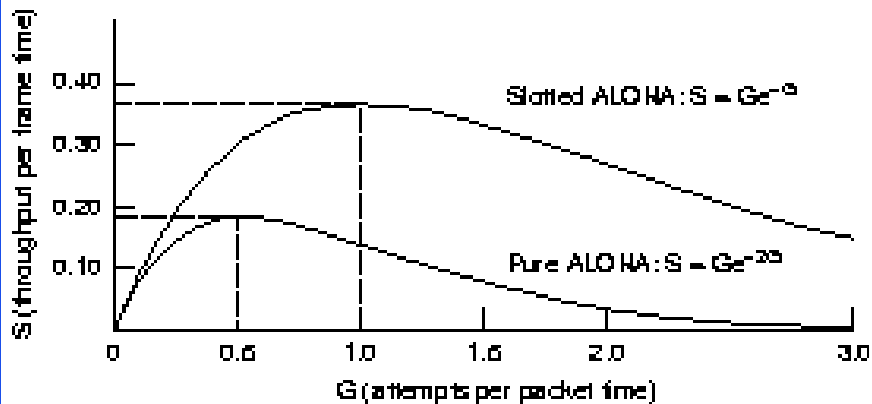

The Ohio State University

Raj Jain

6

## CSMA

- ❑ 1-persistent CSMA: If the channel is idle, transmit  
If the channel is busy, wait until idle and transmit
- ❑ Nonpersistent CSMA: If the channel is busy, go away for a random period of time
- ❑ p-persistent CSMA: Applies to slotted channels.  
If the channel is busy, wait until next slot.  
If the channel is idle, transmit with a probability  $p$  or wait until next slot with probability  $1-p$

The Ohio State University

Raj Jain

7

## CSMA Performance

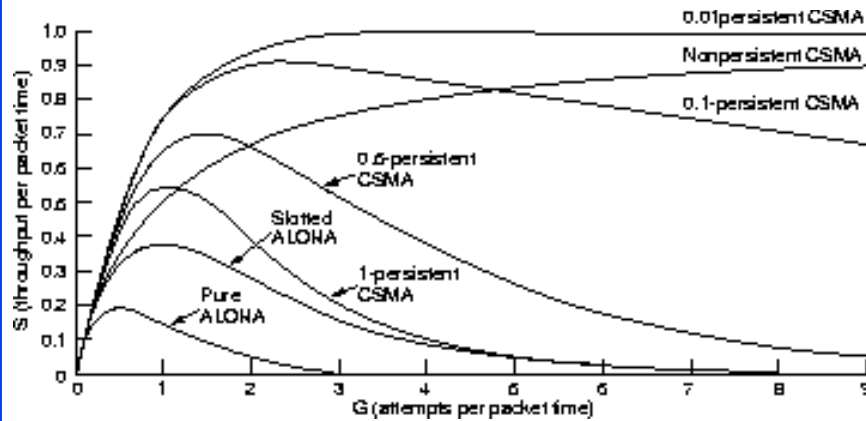

The Ohio State University

Raj Jain

8

## CSMA/CD

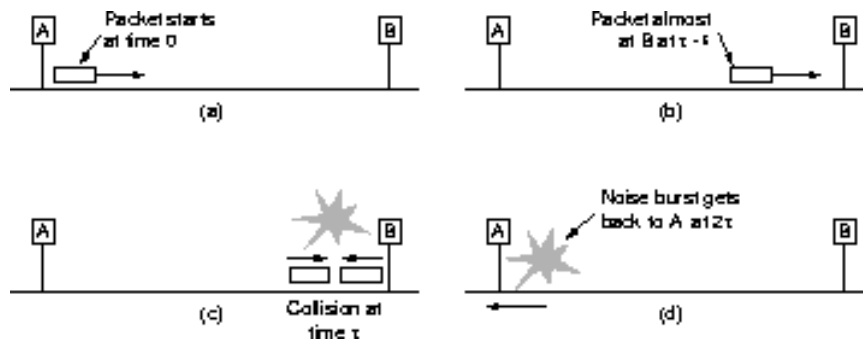

- ❑ Collision detection can take as long as  $2 \times$  One-way propagation delay
- ❑ Packet time  $\geq 2\tau = 51.2 \mu\text{s} = 64$  bytes at 10 Mbps

The Ohio State University

Fig 4-22

Raj Jain

9

## CSMA/CD Performance

- ❑ Efficiency = Max throughput/Line rate =  $P/(P+2\tau/A)$   
 Where, P = Frame time  
 $\tau$  = one-way propagation delay  
 A = P[only one station transmits during a slot ]  
 = fn{# of stations trying to transmit}  
 = 1/e for infinite stations
- ❑ Efficiency =  $1/(1+2\alpha/A)$   
 Where  $\alpha$  = Propagation delay/Frame time  
 = (Distance/Speed of signal)/(Frame size/Data rate)  
 = (Distance  $\times$  Data Rate)/(Frame Size  $\times$  Signal Speed)
- ❑ Efficiency is a decreasing function of  $\alpha$

The Ohio State University

Raj Jain

10

## CSMA/CD Performance

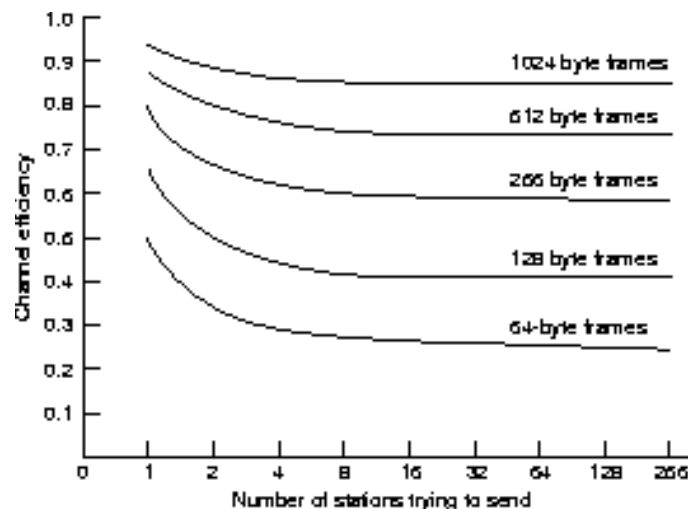

The Ohio State University

Fig 4-23

Raj Jain

11

## IEEE 802.3 CSMA/CD

- ❑ If the medium is idle, transmit (1-persistent).
- ❑ If the medium is busy, wait until idle and then transmit immediately.
- ❑ If a collision is detected while transmitting,
  - ❑ Transmit a jam signal for one slot  
(=  $51.2 \mu\text{s} = 64$  byte times)
  - ❑ Wait for a random time and reattempt (up to 16 times)
  - ❑ Random time =  $\text{Uniform}[0, 2^{\min(k, 10)} - 1]$  slots  
⇒ truncated binary exponential backoff

## IEEE 802.3 CSMA/CD

- ❑ Collision detected by monitoring the voltage  
High voltage ⇒ two or more transmitters  
⇒ Collision
- ❑

## 10Base5 Cabling Rules

- ❑ Thick coax
- ❑ Length of the cable is limited to 2.5 km, no more than 4 repeaters between stations
- ❑ No more than 500 m per segment  $\Rightarrow$  10Base5
- ❑ No more than 2.5 m between stations
- ❑ Transceiver cable limited to 50 m

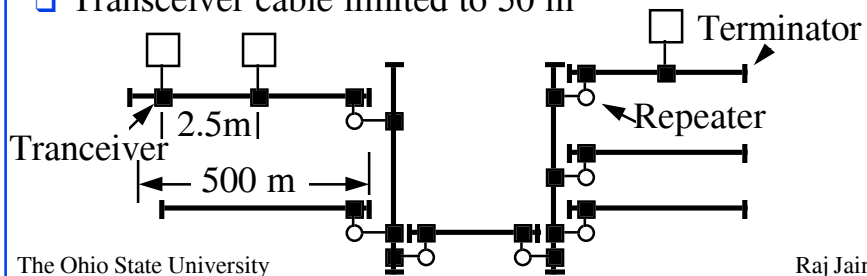

The Ohio State University

Raj Jain

14

## 802.3 PHY Standards

- ❑ **10BASE5:** 10 Mb/s over coaxial cable (ThickWire)
- ❑ **10BROAD36:** 10 Mb/s over broadband cable, 3600 m max segments
- ❑ **10BASE2:** 10 Mb/s over thin RG58 coaxial cable (ThinWire), 185 m max segments
- ❑ **1BASE5:** 1 Mb/s over 2 pairs of UTP
- ❑ **10BASE-T:** 10 Mb/s over 2 pairs of UTP
- ❑ **10BASE-F:** Fiber Optic inter-repeater link (FOIRL), 10BASE-FL (link), 10BASE-FB (backbone), or 10BASE-FP (Passive)

The Ohio State University

Raj Jain

15

## Fast Ethernet Standards

- ❑ **100BASE-T4:** 100 Mb/s over 4 pairs of CAT-3, 4, 5
- ❑ **100BASE-TX:** 100 Mb/s over 2 pairs of CAT-5, STP
- ❑ **100BASE-FX:** 100 Mbps CSMA/CD over 2 fibers
- ❑ **100BASE-X:** 100BASE-TX or 100BASE-FX
- ❑ **100BASE-T:** 100BASE-T4, 100BASE-TX, or 100BASE-FX

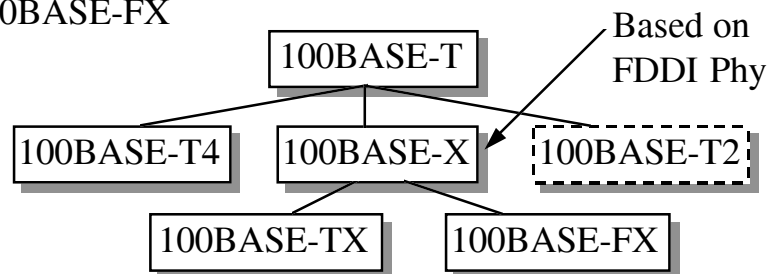

The Ohio State University

Raj Jain

16

## 100 BASE-X

- ❑ X = Cross between IEEE 802.3 and ANSI X3T9.5

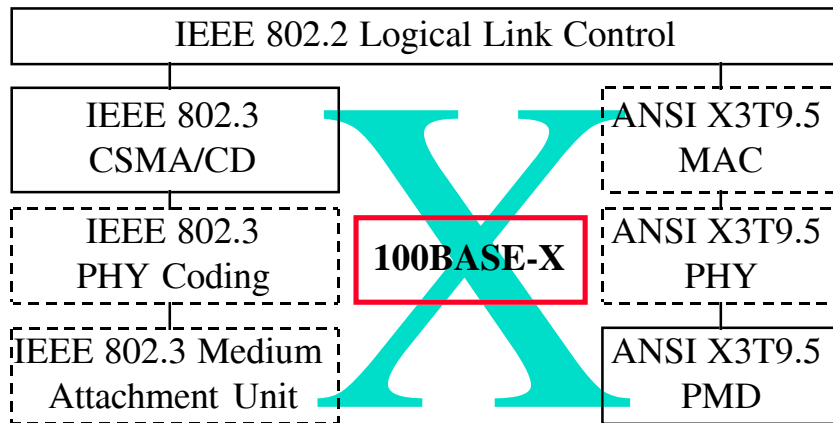

The Ohio State University

Raj Jain

17

## 10BASE5 vs 10BASE-T

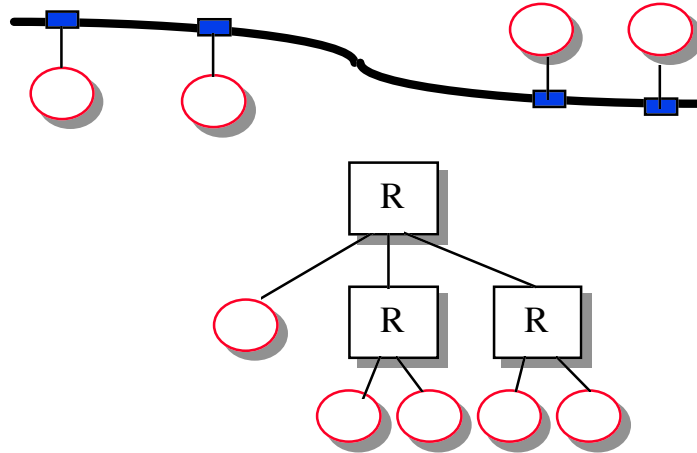

The Ohio State University

Raj Jain

18

## Interconnection Devices

- ❑ **Repeater:** PHY device that restores data and collision signals
- ❑ **Hub:** Multiport repeater + fault detection and recovery
- ❑ **Bridge:** Datalink layer device connecting two or more collision domains. MAC multicasts are propagated throughout “extended LAN.”
- ❑ **Router:** Network layer device. IP, IPX, AppleTalk. Does not propagate MAC multicasts.
- ❑ **Switch:** Multiport bridge with parallel paths

These are functions. Packaging varies.

The Ohio State University

Raj Jain

19

## Interconnection Devices

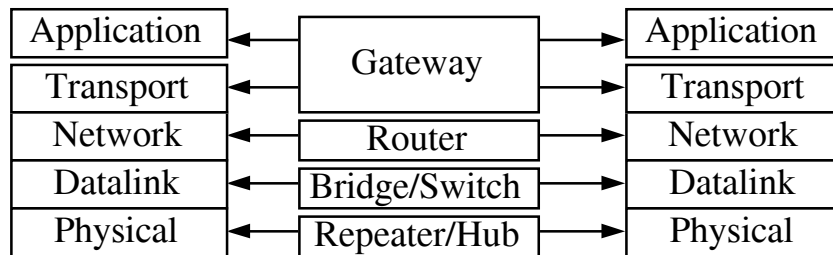
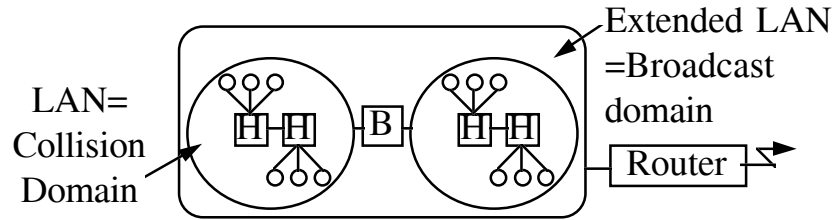

The Ohio State University

Raj Jain

20

## Transparent Bridges

- ❑ Bridges learn the location of stations by monitoring source addresses
- ❑ Stations do not realize that there is a bridge between them  $\Rightarrow$  Transparent

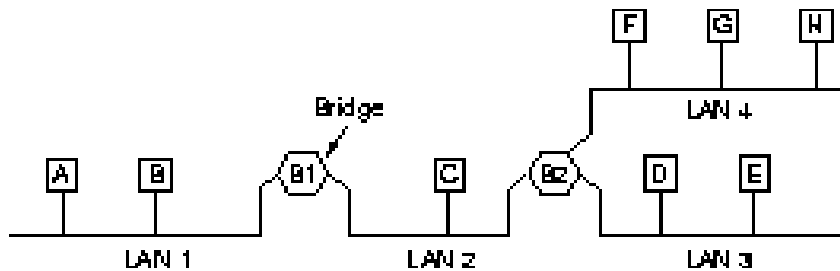

The Ohio State University

Raj Jain

21

## Transparent Bridges (cont)

- They avoid loops by forming a spanning tree  
⇒ Spanning tree bridges

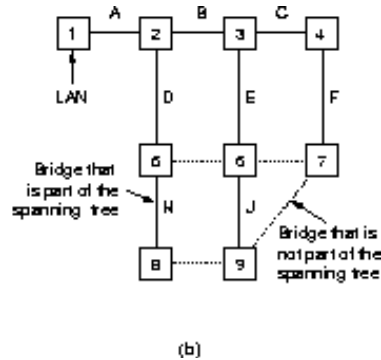
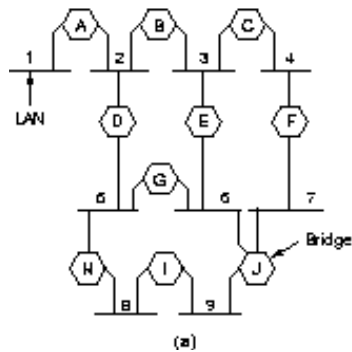

The Ohio State University

Raj Jain

22

## Source Routing Bridges

- Sources specify the route ⇒ list the bridges and the rings that the packet should go through  
L1-B1-L2-B2-L3
- Source find route by **flooding** the route-discovery packet. All bridges indicate the path in the packet.

The Ohio State University

Raj Jain

23

## Remote Bridges

- Bridge distant LANs

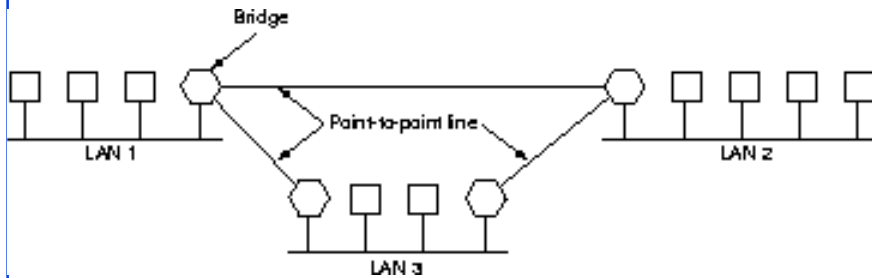

The Ohio State University

Fig 4-43

Raj Jain

24

## Ethernet vs Fast Ethernet

	Ethernet	Fast Ethernet
Speed	10 Mbps	100 Mbps
MAC	CSMA/CD	CSMA/CD
Network diameter	2.5 km	205 m
Topology	Bus, star	Star
Cable	Coax, UTP, Fiber	UTP, Fiber
Standard	802.3	802.3u
Cost	X	2X

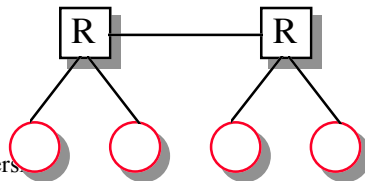

The Ohio State University

Raj Jain

25

## Full-Duplex Ethernet

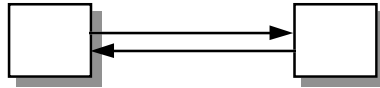

- ❑ Uses point-to-point links between **TWO** nodes
- ❑ Full-duplex bi-directional transmission
- ❑ Transmit any time
- ❑ Not yet standardized in IEEE 802
- ❑ Many vendors are shipping switch/bridge/NICs with full duplex
- ❑ No collisions  $\Rightarrow$  50+ Km on fiber.
- ❑ Between servers and switches or between switches

The Ohio State University

Raj Jain

26

## Manchester Encoding

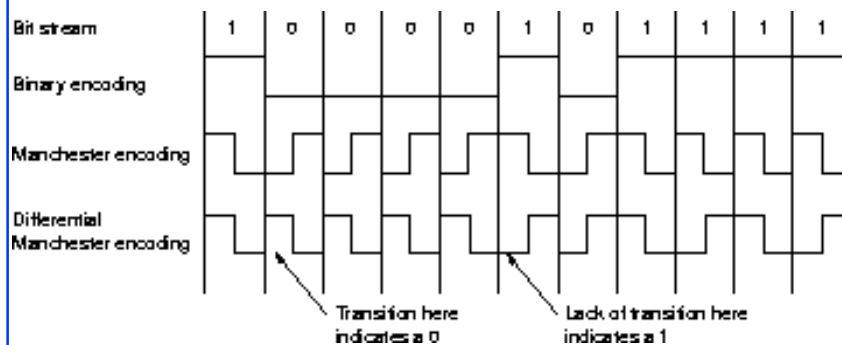

- ❑ Manchester: 1= down, 0 = up
- ❑ Differential Manchester:  
0 = Transition, 1=No transition

The Ohio State University

Raj Jain

27

## Ethernet Address Format

Multicast/ Unicast	Global/ Local	Organizationally Unique ID	
1	1	22	24

- ❑ Multicast = “To all bridges on this LAN”
- ❑ Broadcast = “To all stations”  
= 111111...111 = FF:FF:FF:FF:FF:FF

## Frame Format

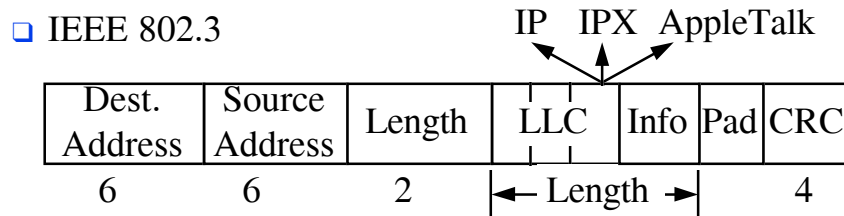
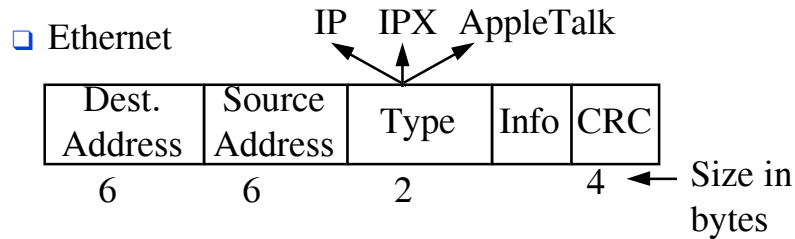

# Logical Link Control

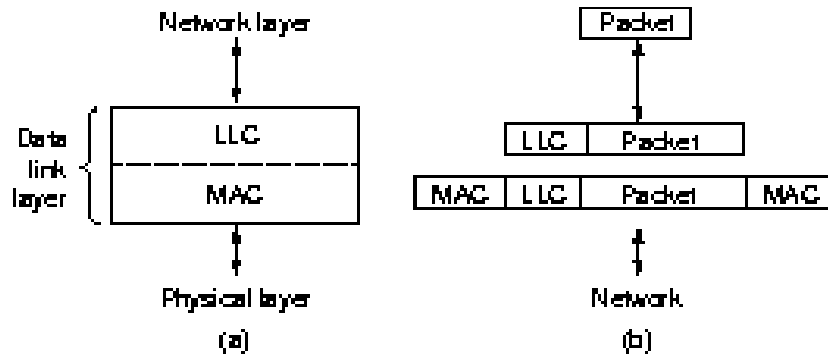

- ❑ LLC used for all IEEE 802 protocols
- ❑ LLC type 1, type 2, type 3, type 4, ...

# Token Ring

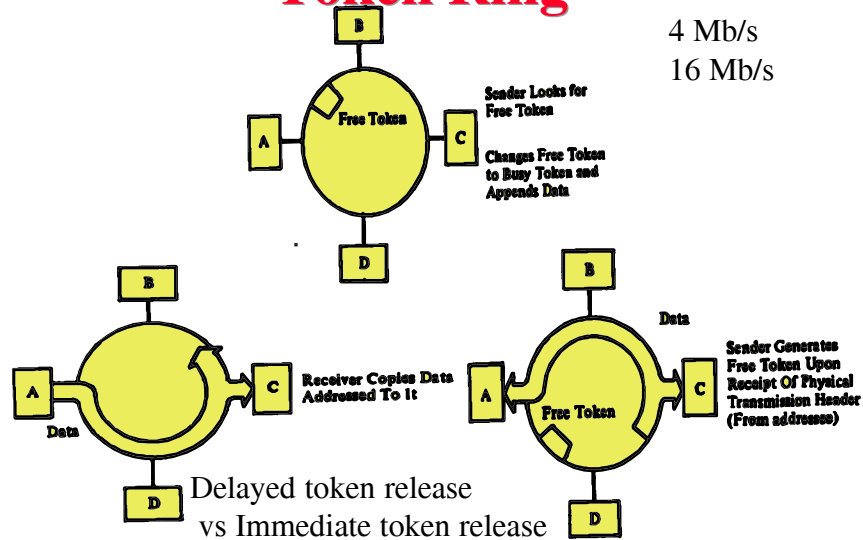

## Priorities

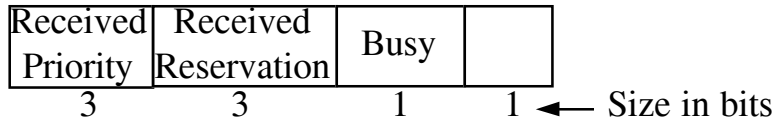

- ❑ Received Priority =  $Pr \Rightarrow$  This token/frame's priority
- ❑ Received reservation =  $Rr$   
 $\Rightarrow$  Someone on the ring wants to transmit at  $Rr$
- ❑ To transmit a message of priority  $Pm$ ,  
you should get a free token with  $Pr \leq Pm$
- ❑ If free but  $Pr > Pm$  and  $Rr < Pm$ ,  
reserve token by setting  $Rr = Pm$
- ❑ If busy and  $Rr < Pm$  then reserve by setting  $Rr \leftarrow Pm$

## Priorities (Cont)

- ❑ If busy and  $Rr > Pm$ , wait
- ❑ When you transmit, set  $Rr = 0$ , and  $busy = 1$ .  
After transmission, issue a new token with  
 $Pr = \text{Max}\{Pr, Pm, Rr\}$ ,  $Rr = \text{Max}\{Rr, Pm\}$

## Homework 9A

Fill in the table with all 8 possible combinations

Busy	Pr<Pm	Rr<Pm	Action

## Priority Stack

- If you issue a higher priority token, remember the new and old priority. Next time grab the higher priority token and reset the priority to old value

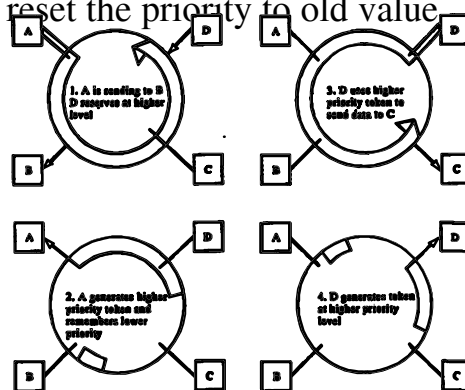

## Priority Stack (continued)

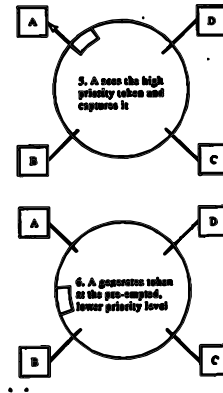

The Ohio State University

Fig 9.19(5-6)

Raj Jain

40

## FDDI

- ❑ Fiber Distributed Data Interface
- ❑ ANSI Standard for 100 Mbps over Fiber and twisted pair
- ❑ Timed token access
- ❑ Up to 500 stations on a single FDDI network
- ❑ Inter-node links of up to 2km on multimode fiber, 60+ km on single mode fiber, Longer SONET links, 100 m on UTP.
- ❑ Round-trip signal path limited to 200 km  $\Rightarrow$  100 km cable.

The Ohio State University

Raj Jain

41

## FDDI (cont)

- ❑ Maximum frame size is 4500 bytes.
- ❑ Eight priority levels
- ❑ Synchronous (guaranteed access delay) and asynchronous traffic
- ❑ Arranged as single- or dual-ring logical topology

## Dual Rings: Wrap

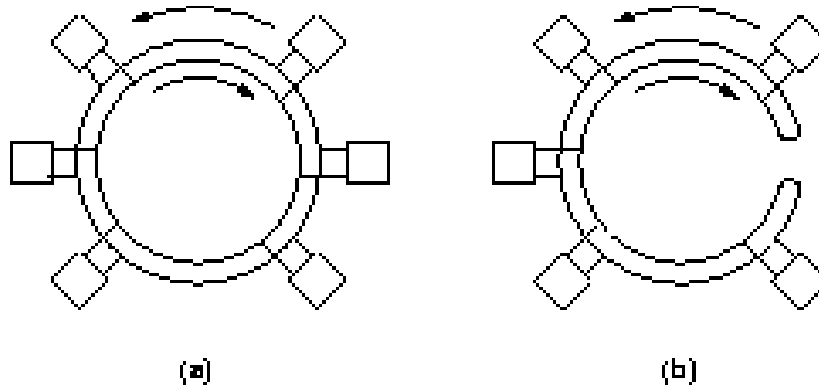

- ❑ Counterrotating rings

## Dual-Ring of Trees Topology

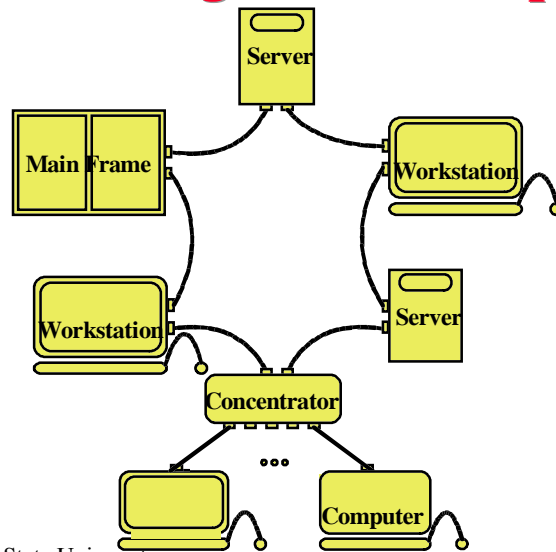

The Ohio State University

Raj Jain

44

## Timed Token Access

- ❑ Two classes of traffic: Synchronous, Asynchronous
- ❑ Asynchronous: Timed token access
- ❑ Stations agree on a target token rotation time (TTRT)
- ❑ Stations monitor token rotation time (TRT)
- ❑ A station can transmit  $TTRT - TRT$   
=Token Holding Time (THT)
- ❑ Yellow Light Rule:  
Complete the frame if THT expires in the middle of a frame
- ❑ Immediate Release:  
Release the token at the end of frame transmission

The Ohio State University

Raj Jain

46

## Timed Token Access (Cont)

- If  $TRT > TTRT$ , Increment late count (LC)
- Reinitialize the ring if  $LC = 2$
- Synchronous:  $i$ th station can transmit  $SA_i$  (pre-allocated)

## TRT

- Maximum  $TRT = TTRT + \text{Max Frame time} + \text{Token Time} + \sum SA_i$
- It is required that  $\sum SA_i < TTRT - \text{Max Frame time} - \text{Token Time}$
- Maximum  $TRT = 2 TTRT$
- If  $D = \text{Ring latency}$ , then  
Utilization  $U = (TRT - D) / TRT = 1 - D / TRT$
- High load  $\Rightarrow$  High TRT  
Low load  $\Rightarrow$  Low TRT
- Lower priority traffic allowed only if TRT is low
- Set  $TTRT_0 < TTRT_1 < TTRT_2 < \dots < TTRT_6$

## Priorities

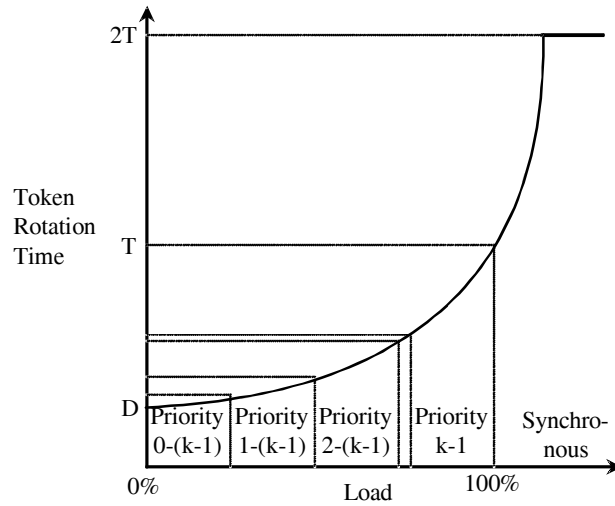

The Ohio State University

Raj Jain

49

## Summary



- ❑ Ethernet/IEEE 802.3: CSMA/CD, Baseband, broadband
- ❑ Fast Ethernet
- ❑ Token ring/IEEE 802.5
- ❑ FDDI Timed token access
- ❑ LLC
- ❑ Transparent and source routing bridges

The Ohio State University

Raj Jain

50

## Homework

- Read sections 4.2.1, 4.2.2, 4.3.1, 4.3.3, 4.3.5, 4.3.6, 4.4, 4.5.1, 4.5.2
- Problems: 1, 3, 4, 5, 6, 18, 21, 22, 26, 28, 30, 32, 41